

WEST VIRGINIA

LEGISLATURE

2026

PAGE PROGRAM

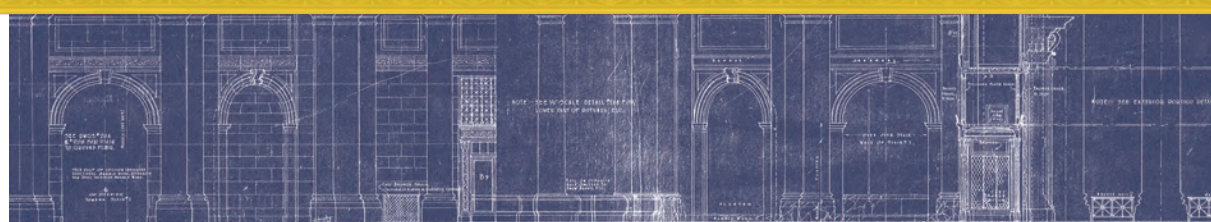
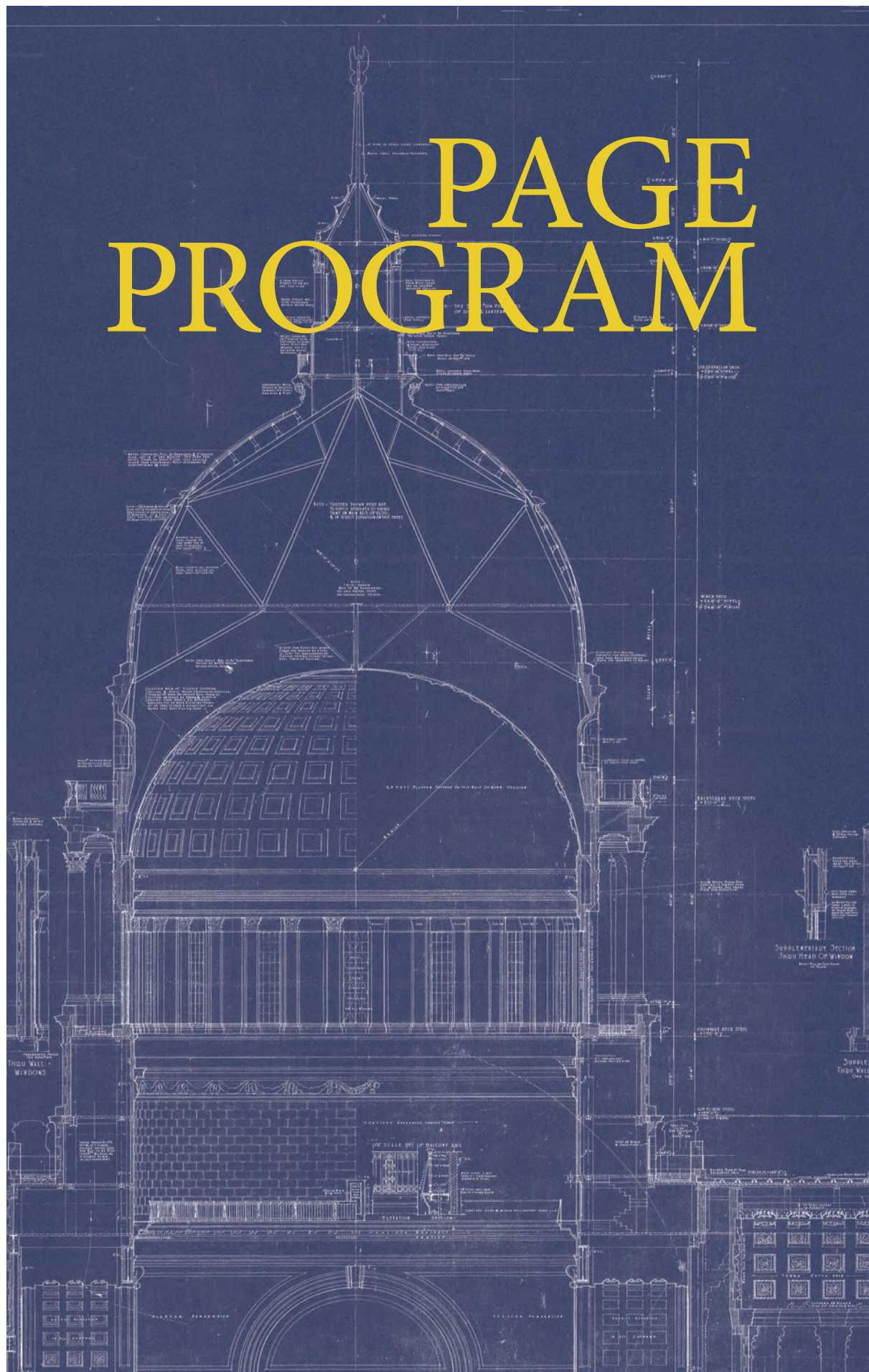



WEST VIRGINIA LEGISLATURE
STATE CAPITOL
CHARLESTON, WEST VIRGINIA 25305

Randy Smith
Senate President/Lieutenant Governor

Roger Hanshaw
Speaker of the House

Lee Cassis
Clerk of the Senate

Jeff Pack
Clerk of the House

Welcome to the West Virginia Legislature:

We are pleased you have chosen to participate in the West Virginia Legislature's Page Program. It is our pleasure to make your time with us informative, interesting, and enjoyable. This program has been designed to outline the procedures you will follow while serving as a Page in the Senate or in the House of Delegates.

We appreciate your interest in state government and are confident your day with us will provide a better understanding of the legislative process.

The historical data included in this program will be helpful in your various classes. Please contact the Senate Clerk's Office or the House Clerk's Office if you require additional information or assistance.

Enjoy your visit to your State Capitol and thank you for serving our Members.

Handwritten signature of Randy E. Smith in blue ink, written over a horizontal line.

Randy E. Smith
Senate President/Lieutenant Governor

Handwritten signature of Roger Hanshaw in blue ink, written over a horizontal line.

Roger Hanshaw
Speaker of the House

Handwritten signature of Lee Cassis in blue ink, written over a horizontal line.

Lee Cassis
Clerk of the Senate

Handwritten signature of Jeff Pack in blue ink, written over a horizontal line.

Jeff Pack
Clerk of the House

PREFACE

Since the inception of the Legislative Page Program in 1993, its intent has been to provide a learning experience for youth in the legislative process. Our goal is to present educational and historical information to students participating as Pages during the Regular Session of the Legislature.

Among other things in the Legislative Page Program Book, students will find an explanation of the rules governing the actions of Senators and Delegates as they deliberate legislation on the Chamber Floors of both houses. There is a diagram which covers the basic overview of how a bill moves through the legislative process on its way to becoming law. Students will also find lists of current Senators and Delegates, an overview of the Standing Committees of the Senate and House of Delegates and instructions on proper etiquette when on the Senate or House Chamber Floors. Maps are included to help students find their way around the Capitol Building.

It is our hope that students serving as Legislative Pages find this experience enjoyable, informative and useful in their educational pursuits and that they come away with a better understanding of the legislative process and an interest in effecting positive change in our state.

TABLE OF CONTENTS

Preface	1
General Instructions	5
Senate of West Virginia	9
Officers of the Senate	11
Members of the Senate	13
Prior to Session.....	14
Daily Order of Business and Procedure	14
Voting Requirements of the Senate	17
Standing Committees of the Senate	19
Senate Seating Chart	21
House of Delegates	23
Officers of the House of Delegates	25
Members of the House of Delegates	27
Prior to Session.....	30
Precedence of Motions	30
Required Votes	31
Order of Business	32
Standing Committees	33
House Seating Chart	37
Maps and Districts	39

State Government.....	51
Government Organizational Chart.....	53
WV Legislative Process	54
Legislative Glossary	55
Elected Offices.....	57
Budget	59
Historical Data.....	65
State Profile.....	67
Legislative Leadership	71
County History.....	74
WV Government	80
Capitol History	82
Governors of West Virginia	84
WV History Timeline	87
WV Facts.....	93
Famous West Virginians	97
Presidents of the United States	100
Federal Flag Code.....	102
Respect for the Flag	104
History of the American Flag	106
Points of Interest	107

GENERAL INSTRUCTIONS

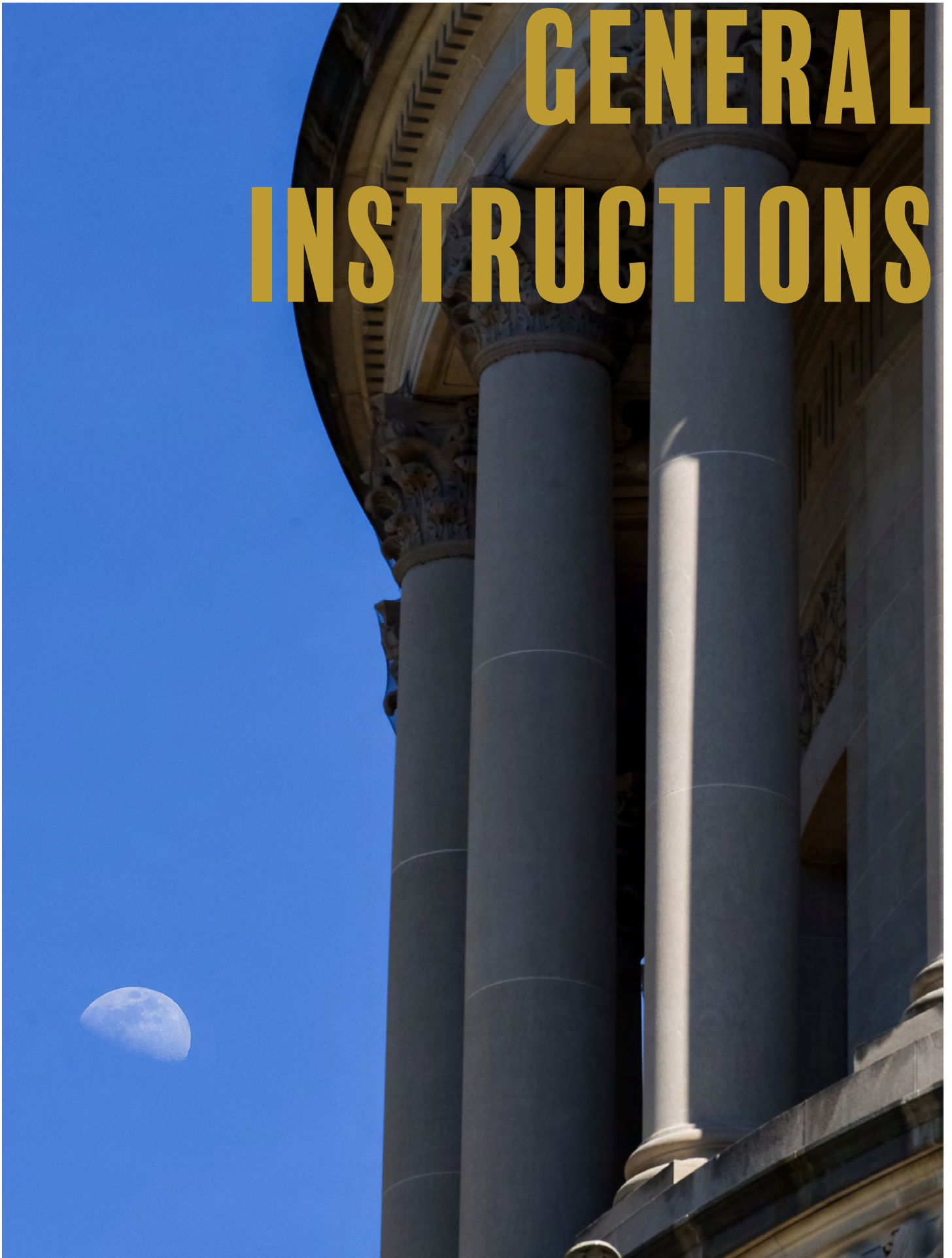

INSTRUCTIONS

The West Virginia Legislative Page Program has become an integral part of the Senate and House of Delegates service to its members and the public. It has been a communications link between the Senators and Delegates and our young students.

The Page Program gives students, ages 12-18 years old from West Virginia an opportunity to serve as Pages in the West Virginia Senate or House of Delegates during the legislative session. Pages serve Members of the Legislature from their district in a nonpartisan capacity.

The program accomplishes the following objectives:

- Provides students with a meaningful and exciting experience in state government;
- Students meet and work with other young people, their State Senators, Delegates and those from different areas of the state;
- Gives students firsthand learning experiences regarding the role of the legislators and their influence in effecting positive change in the state;
- Young people gain a better understanding of state government and the legislative process. They can share this knowledge with others in their respective schools and communities.

GENERAL COMMENTS

Through your participation in the Page Program, you represent your school, your community and the youth of West Virginia to the legislators. The image you project will be part of an overall impression of the West Virginia Legislature and to visitors at the State Capitol. We want you to enjoy your day as a Page. Relax, use common sense, and show courtesy and sensitivity to others. Feel free to ask for help when you need it. The Head Pages will be happy to answer your questions.

NOTES OF PERSONAL INTEREST

- The cafeteria is located in the basement of the Capitol building. Hours are 7:00am-1:30pm.
- Restrooms are conveniently located in the main unit of Building 1.
- Valuables and other personal belongings should be left in a secure area.
- Check with the Head Pages for assistance.

SECURITY

Your safety is of great concern to us! It is imperative that the Head Pages or Doorkeepers know where you are at all times. A diagram is provided in this page program book indicating the area you are to serve during your time with us.

INSTRUCTIONS

RULES

When the Legislature is in session, we request that you refrain from talking. We must be considerate of staff personnel working. Always avoid unnecessary conversation or distractions while awaiting a call from the Senators or Delegates.

- Chewing gum is never allowed in the Chamber.
- Cell phones are not permitted in either Chamber.
- Always check with the Head Page before leaving the Chamber.
- Seating arrangement diagrams for the Senators or Delegates in the Chamber are provided to each Page.
- Listen carefully to the instructions/training from Legislators and Head Page. If you do not understand their instructions, politely ask that they repeat them.
- If you are still uncertain about directions or if you do not know how to fulfill the errand, go directly to the Head Page.
- If you are asked to carry a message from one member to another, you may use the seating chart which has been provided.
- At the end of the Session you may have your picture taken with your sponsoring Senator or Delegate.
- You will receive a certificate signed by either the President of the Senate and the Senate Clerk or the Speaker of the House and the House Clerk depending on which legislative body in which you serve.

When answering a light:

- Never walk in front of a legislator who is speaking.
- Never walk between two legislators who are debating.
- Never walk in front of a legislator who is seeking recognition from the President or the Speaker.
- Never walk in center aisle.

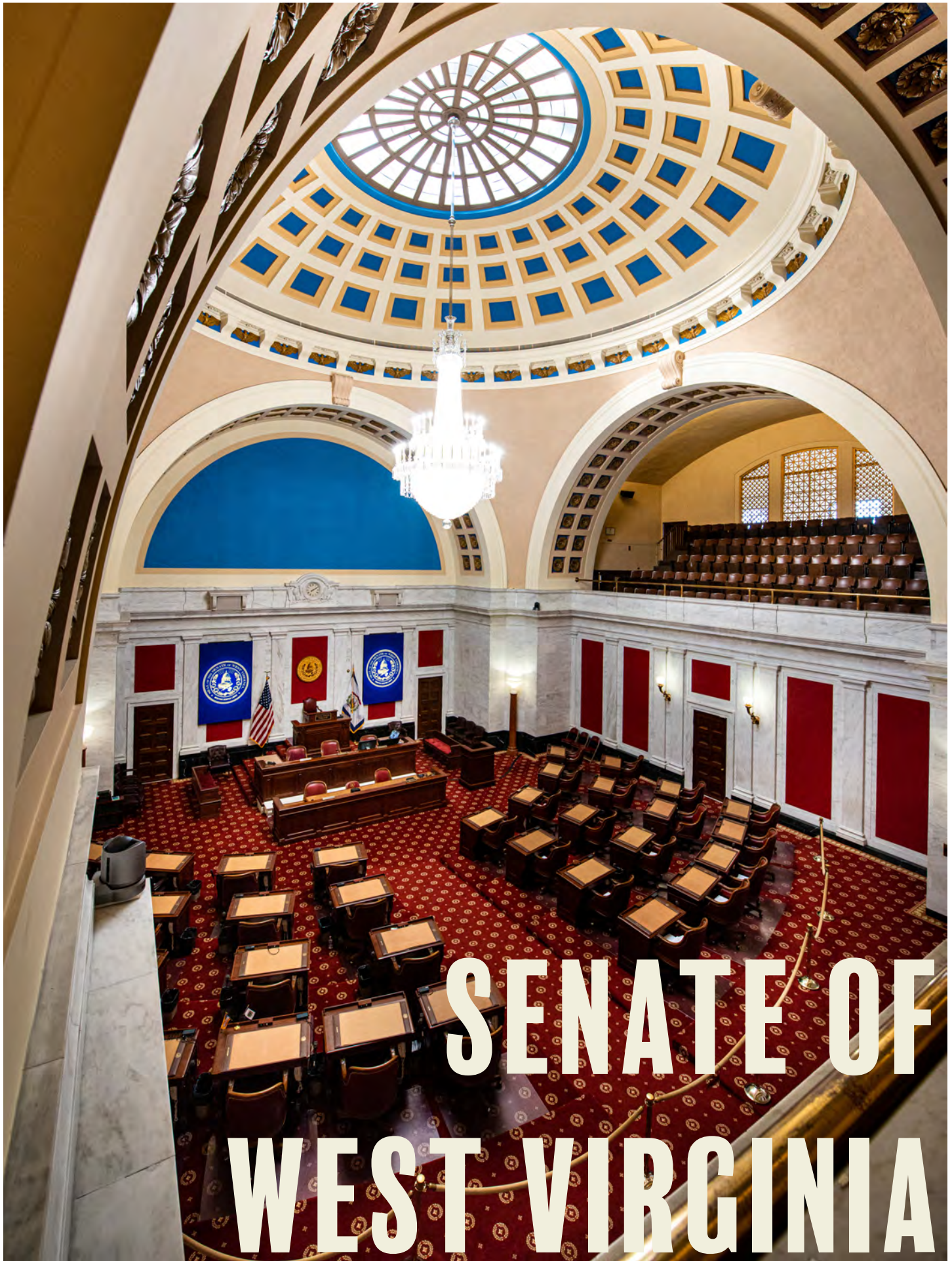

SENATE OF WEST VIRGINIA

OFFICERS OF THE SENATE

President of the Senate	Randy E. Smith
Clerk of the Senate	Lee Cassis
President Pro Tempore.....	Jay Taylor
Majority Leader	Patrick S. Martin
Assistant Majority Leader.....	Patricia Rucker
Majority Whip	Ben Queen
Minority Leader.....	Michael A. Woelfel
Assistant Minority Leader	Joey Garcia
Sergeant at Arms	Steve Walker
Doorkeeper	Ralph Coleman

WEST VIRGINIA SENATE

87th Legislature - 2026

Senate President
Randy E. Smith



Azinger, Michael T. (R)



Barnhart, Trenton (R)



Barrett, Jason (R)



Bartlett, T. Kevan (R)



Chapman, Laura (R)



Charnock, Anne B. (R)



Clements, Charles H. (R)



Deeds, Vince (R)



Fuller, Scott (R)



Garcia, Joey (D)



Grady, Amy N. (R)



Hamilton, Bill (R)



Hart, Craig A. (R)



Helton, Brian (R)



Jeffries, Glenn D. (R)



Martin, Patrick S. (R)



Maynard, Mark R. (R)



Maynard, Zack (R)



Morris, Robbie (R)



Oliverio II, Michael A. (R)



Phillips, Rupie (R)



Queen, Ben (R)



Roberts, Rollan A. (R)



Rose, Chris (R)



Rucker, Patricia (R)



Takubo, Tom (R)



Tarr, Eric J. (R)



Taylor, Jay (R)



Thorne, Darren (R)



Weld, Ryan W. (R)



Willis, Tom (R)



Woelfel, Michael A. (D)



Woodrum, Jack David (R)



Senate Clerk
Lee Cassis

DAILY ORDER OF BUSINESS AND PROCEDURE

- **To read, correct and approve the Journal.**
A daily Journal of the proceedings of the Senate is kept. At the beginning of each day, the Clerk will begin reading the Journal of the previous day. A motion by a senator to approve the Journal will cease the reading.
- **Introduction of guests.**
If a Senator has guests who are visiting the Senate, once recognized by the President, he or she will rise and will introduce his or her guests.
- **To dispose of communications from the House of Delegates and the Executive.**
The Senate and House of Delegates have an official way of communicating with each other during a session. These communications are called messages. These messages from the House of Delegates are read by the Clerk and the appropriate legislative action is taken. Also, under this order of business, the Governor can send communications to the Senate. These are called Executive Messages. Once a message from the Governor has been read, the appropriate legislative action is taken.
- **To receive reports from standing committees.**
A standing committee is a group of Senators, along with their chair, who has been appointed by the President, to meet on bills sent to their committees. There are 19 standing committees in the Senate. If they have acted favorably on a bill that has been sent to their committee, they must report that action to the full Senate.

DAILY ORDER OF BUSINESS AND PROCEDURE

- **To receive reports from select committees.**
A select committee is a group of Senators appointed by the President to act on issues other than those brought before a standing committee.
- **To receive bills, resolutions, motions and petitions.**
Bills and resolutions being introduced in the Senate for the first time are read, and the President will refer the bill to the appropriate committee. Motions are also considered under this order of business, and petitions signed by citizens on a given subject are presented and referred to the appropriate committee.
- **To act upon unfinished business of the preceding day and resolutions lying over from the previous day, and no resolution shall lose its place on the calendar by not being acted upon on the day following that on which it was offered.**
Any business that the Senate may have held over from the previous day is considered under this order of business.
- **Senate and House Bills on third reading. (Passage Stage)**
Senators will debate and vote on Senate and House Bills.
- **Senate and House Bills on second reading. (Amendment Stage)**
Senators or Standing Committees can offer amendments to Senate or House Bills.
- **Senate and House Bills on first reading.**
Bills that have been reported from committees are read.
- **Introduction of guests.**
If a Senator has guests visiting the Senate, he or she will rise and, once recognized by the President, will introduce his or her guests.
- **Remarks by Members of the Senate.**
Senators can make remarks regarding any subject.
- **Miscellaneous business.**
Matters that are not in the official order of business are considered.

RESPONSIBILITIES OF THE SENATE PRESIDENT

By Senate Rule:

- Presides over the Senate.
- Refers bills, resolutions and joint resolutions to committee.
- Has control of all the corridors, passageways and rooms as well as the Senate Chamber.
- Appoints standing committees, their chairpersons and their members (with choice of minority members delegated to the minority caucus), and sets criteria for “balance” on the committees (e.g., geographical, political, occupational).
- Signs all Acts, Resolutions, Writs, Warrants, and Subpoenas issued or ordered by the Senate.
- Sets schedule for committee meetings.
- Appoints Senate members to conference committees.
- Chair of the Senate Rules Committee.
- Co-chair of the Joint Committee on Government and Finance. The other co-chairman is the Speaker of the House of Delegates.

VOTING REQUIREMENTS

VOTES REQUIRING MEMBERS ELECTED

Election of Officers

Senate Rule 3. A majority of members elected shall be necessary to elect officers.

House Amendments to Senate Bill

Senate Rule 26. The affirmative vote of a majority of all members elected shall be necessary to repass a bill or joint resolution that has been amended by the House of Delegates.

Constitutional Amendments

Senate Rule 58. A majority of members present may pass amendments to constitutional amendments, but the proposed constitutional amendment requires a two-thirds vote of members elected for passage.

VOTES REQUIRING MEMBERS PRESENT

Session

Senate Rule 1. Two members may adjourn a session, three members may order a call of a session, send for absentees and make any order for their censure or discharge.

Senate Rule 2. If less than a quorum is present, the members present may send the Sergeant at Arms or any other person they may authorize for any or all absent members.

Introduction of Bills

Senate Rule 15. To introduce a bill or resolution from the floor takes a majority of those present.

Resolutions

Senate Rule 16. Majority of members present may elect to overrule the requirement for concurrent and simple resolutions to lie on the table for at least one day.

Senate Rule 18. Majority of members present may elect to overrule the requirement that all bills and resolutions reported from the House of Delegates shall be read by their titles and referred to the appropriate committee.

Senate Rule 19. By a vote of four-fifths of the members present, the constitutional rule requiring bills or joint resolutions to be read on three different days may be dispensed with.

Printing of Bills

Senate Rule 21. A majority of the members present may dispense with the rule requiring printing of bills prior to advancement to second reading.

Select Committees

Senate Rule 30. A majority of members present may direct that the composition of select committees may be other than not less than three nor more than five members.

Executive Sessions

Senate Rule 32. An executive session may be held only upon a majority vote of the members present.

Bill Withdrawal from Committee or Taken from Table

Senate Rule 34. A majority of members present may withdraw a bill, resolution or other business from the committee to which it has been referred, or that it be taken from the table and placed upon the calendar.

Previous Question

Senate Rule 41. A majority of members present may make a motion for the previous question.

Reconsideration of vote

Senate Rule 42. Any member who voted with the prevailing side on a question may move to reconsider that vote at any time on the same day or the next succeeding day of actual session.

Excused from Voting

Senate Rule 43. A motion to excuse a member from voting on a question must be made by the member requesting to be excused prior to the division of the question or before the call of the yeas and nays is commenced.

Constitutional Amendments

Senate Rule 58. A majority of members present may pass amendments to constitutional amendments, but the proposed constitutional amendment requires a two-thirds vote of members elected for passage.

Rule Suspension

Senate Rule 61. Two-thirds of members present may suspend a standing rule or order of the Senate.

PRECEDENCE OF MOTIONS

Senate Rule 39.

- To adjourn (not debatable and shall not be amended).
- To lay on the table (not debatable and shall not be amended).
- For the previous question.
- To postpone the question to a different day.
- To commit.
- To amend.
- To postpone indefinitely.

MOTIONS - *NOT DEBATABLE AND SHALL NOT BE AMENDED*

Senate Rule 40.

- To adjourn.
- To fix the time to which the Senate shall adjourn.
- To lay on the table.
- For the previous question.
- To suspend the constitutional rule requiring bills to be read on three separate days.
- To recess.
- To postpone indefinitely.

SENATE - LEADERSHIP

President of the Senate Randy E. Smith
President Pro Tempore: Jay Taylor
Majority Leader: Patrick Martin
Assistant Majority Leader: Patricia Rucker
Majority Whip: Ben Queen
Minority Leader: Mike Woelfel
Assistant Minority Leader: Joey Garcia

SENATE - STANDING COMMITTEES

Agriculture

Craig Hart - Chair
Darren Thorne - Vice Chair
Deeds, Hamilton, Queen, Rose, Rucker, Tarr, Woelfel

Banking and Insurance

Michael Azinger - Chair
Tranton Barnhart - Vice Chair
Barrett, Chapman, Charnock, Fuller, Garcia, Morris, Oliverio

Confirmations

Anne Charnock - Chair
Azinger, Barnhart, Barrett, Rose, Taylor, Weld, Woelfel

Economic Development

Glenn Jeffries - Chair
Robbie Morris - Vice Chair
Barnhart, Barrett, Charnock, Clements, Hamilton, Maynard, Oliverio, Phillips, Thorne, Weld, Woelfel, Woodrum

Education

Amy Grady - Chair
Charles Clements - Vice Chair
Azinger, Barnhart, Bartlett, Deeds, Fuller, Garcia, Hart, Oliverio, Roberts, Tarr, Taylor

Energy, Industry and Mining

Chris Rose - Chair
Ben Queen - Vice Chair
Azinger, Barnhart, Charnock, Fuller, Garcia, Hart, Helton, Jeffries, Maynard, Phillips, Taylor

Enrolled Bills

Jack Woodrum - Chair
Scott Fuller - Vice Chair
Jeffries, Maynard, Roberts, Woelfel

Finance

Jason Barrett - Chair
Rollan Roberts - Vice Chair
Barnhart, Clements, Grady, Hamilton, Jeffries, Martin, Maynard, Morris, Oliverio, Phillips, Queen, Takubo, Thorne, Woelfel, Woodrum

Government Organization

Robbie Morris - Chair
Jack Woodrum - Vice Chair
Barrett, Charnock, Hamilton, Helton, Jeffries, Maynard, Maynard, Phillips, Rose, Rucker, Thorne, Weld, Woelfel

Health and Human Resources

Brian Helton - Chair

Vince Deeds - Vice Chair

Azinger, Bartlett, Fuller, Garcia, Grady, Martin, Maynard, Queen, Roberts, Rose, Rucker, Takubo, Taylor, Willis

Interstate Cooperation

Michael Oliverio - Chair

Brian Helton - Vice Chair

Bartlett, Garcia, Queen, Taylor, Willis

Judiciary

Tom Willis - Chair

T. Kevan Bartlett - Vice Chair

Azinger, Chapman, Charnock, Deeds, Fuller, Garcia, Hart, Helton, Martin, Maynard, Rose, Rucker, Tarr, Taylor, Weld

Military

Ryan Weld - Chair

Scott Fuller - Vice Chair

Bartlett, Clements, Deeds, Grady, Tarr, Taylor, Willis, Woelfel

Natural Resources

Bill Hamilton - Chair

Vince Deeds - Vice Chair

Garcia, Hart, Jeffries, Morris, Queen, Rose, Tarr, Woodrum

Pensions

Michael Oliverio - Chair

T. Kevan Bartlett - Vice Chair

Barrett, Clements, Hamilton, Takubo, Tarr, Thorne, Willis, Woelfel

Rules

Randy Smith - Chair

Patrick Martin - Vice Chair

Barrett, Chapman, Grady, Maynard, Rucker, Taylor, Woelfel

Select Committee on School Choice

Patricia Rucker - Chair

Jay Taylor - Vice Chair

Azinger, Clements, Maynard, Roberts, Rose, Thorne, Woelfel

Select Committee on Substance Use Disorder and Mental Health

Brian Helton - Chair

Scott Fuller - Vice Chair

Deeds, Takubo, Tarr, Weld, Woelfel

Transportation and Infrastructure

Mark Maynard - Chair

Jay Taylor - Vice Chair

Clements, Garcia, Hart, Helton, Jeffries, Maynard, Morris, Oliverio, Rucker

Workforce

Rollan Roberts - Chair

Jack Woodrum - Vice Chair

Deeds, Fuller, Hamilton, Queen, Rose, Tarr, Thorne, Weld, Woelfel

WEST VIRGINIA SENATE

87th Legislature

2026

Press



Sergeant at Arms



Doorkeeper

Press

Smith Sr. - 14th Preston 25	Barnhart Jr. - 3rd Pleasants 26	Deeds Jr. - 10th Greenbrier 27	Weld Sr. - 1st Brooke 28	Hamilton Sr. - 11th Upshur 29	Clements Sr. - 2nd Wetzel 30	Takubo Sr. - 17th Kanawha 31	Jeffries Sr. - 8th Putnam 32	Maynard, Z. Jr. - 7th Lincoln 33	Tarr Sr. - 4th Putnam 34
Chapman Jr. - 1st Ohio 17	Hart Jr. - 6th Mingo 18	Phillips Sr. - 7th Logan 10	Fuller Jr. - 5th Wayne 11	Thorne Sr. - 15th Hampshire 20	Taylor Jr. - 14th Taylor 21	Maynard, M. Sr. - 6th Wayne 22	Rose Jr. - 2nd Monongalia 23	Rucker Sr. - 16th Jefferson 24	Morris Jr. - 11th Randolph 16
Charnock Jr. 17th Kanawha 9	Oliverio Sr. - 13th Monongalia 2	Azinger Sr. - 3rd Wood 12	Garcia Jr. - 13th Marion 3	Woelfel Sr. - 5th Cabell 4	Queen Jr. - 12th Harrison 13	Bartlett Jr. - 8th Kanawha 14	Helton Jr. - 9th Fayette 15	Willis Jr. - 15th Berkeley 8	Grady Jr. - 4th Mason 7
Woodrum Sr. - 10th Summers 1					Martin Sr. - 12th Lewis 5	Barrett Jr. - 16th Berkeley 6			

Senate Clerk
Lee Cassis & Staff

Senate President
Randy E. Smith

Pages

Pages

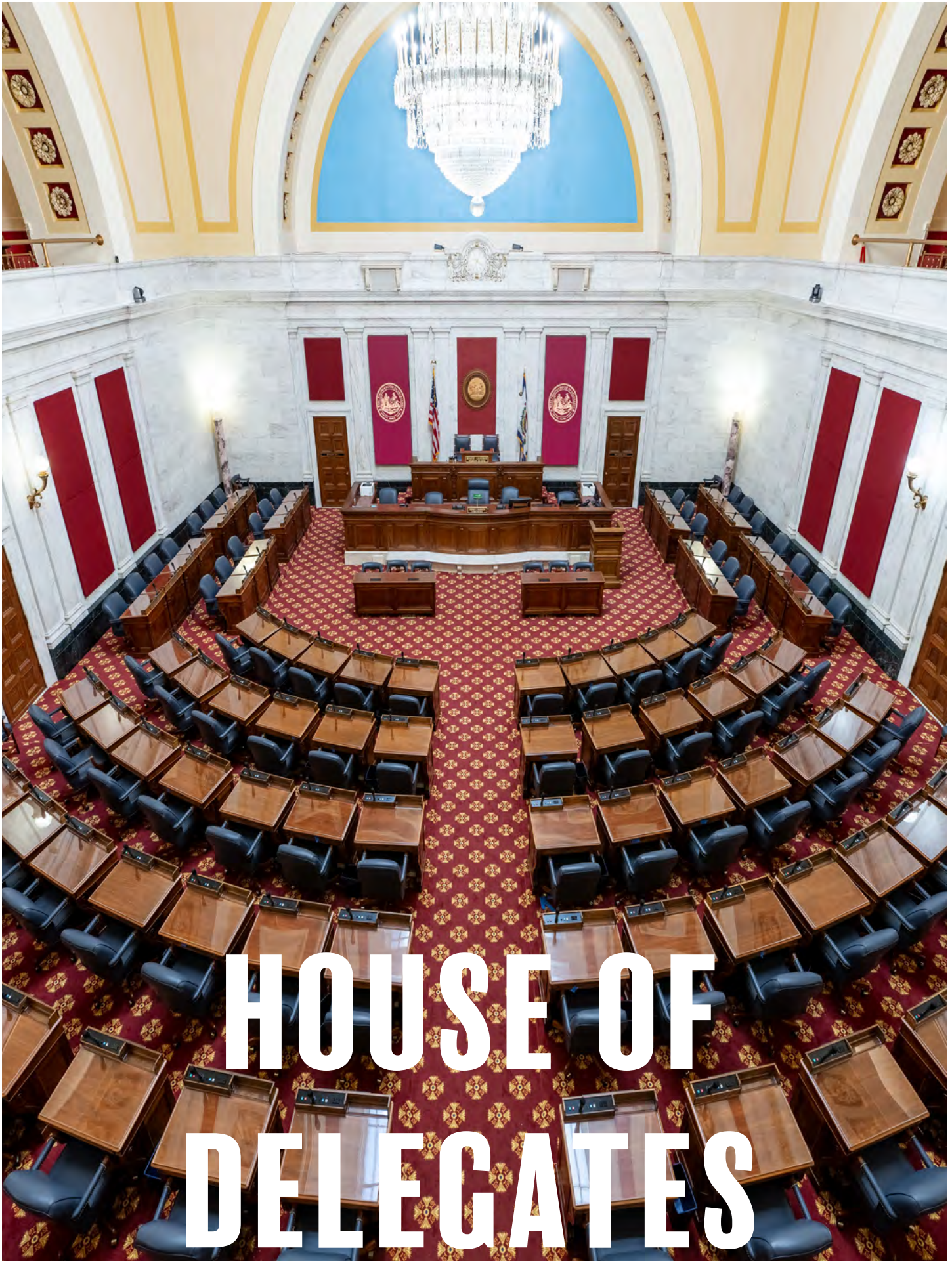

HOUSE OF DELEGATES

OFFICERS OF THE HOUSE

Speaker of the House	Roger Hanshaw
Clerk of the House.....	Jeff Pack
Majority Leader	Pat McGeehan
Majority Whip	Marty Gearheart
Speaker Pro Tempore, Deputy Speaker	Matthew Rohrbach
Deputy Speaker	Joe Ellington
Assistant Majority Leaders	David Elliott Pritt, David Green, Erica Moore, David McCormick, Mickey Petitto
Assistant Majority Whips ..	Jordan Bridges, Eric Brooks, Jim Bulter, Sarah Drennan, Dave Foggin, Joe Funkhouser, Jonathan Pinson, Bill Ridenour
Minority Leader	Sean Hornbuckle
Minority Whip.....	Shawn Fluharty
Minority Leader Pro Tempore	Kayla Young
Sergeant at Arms	Ed Hart
Doorkeeper	Robert Stewart

WEST VIRGINIA HOUSE OF DELEGATES

87th Legislature - 2026



House Speaker
Roger Hanshaw



Adkins, Stanley (R)



Akers, J.B. (R)



Amos, Michael (R)



Anders, Chris (R)



Anderson, Bill (R)



Bell, Bill (R)

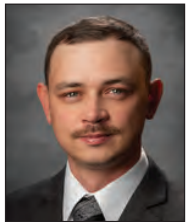

Bridges, Jordan (R)



Brooks, Eric (R)



Browning, Ryan (R)



Burkhammer, Adam (R)



Butler, Jim (R)



Campbell, Jeff (R)



Cannon, David (R)



Cannon, Jarred (R)



Canterbury, Ray (R)



Chiarelli, Geno (R)



Clark, Wayne (R)



Clay, Marshall (R)



Cooper, Roy (R)



Coop-Gonzalez, Elias (R)



Criss, Vernon (R)



Crouse, Kathie Hess (R)



Dean, Mark (R)



Dillon, Henry C. (R)



Dittman, Lori (R)



Drennan, Sarah (R)



Eldridge, Jeff (R)



Ellington, Joe (R)



Fehrenbacher, Bob (R)



Ferrell, Dana (R)



Flanigan, Bill (R)



Fluharty, Shawn (D)



Foggin, Dave (R)



Funkhouser, Joe (R)



Garcia, Rick (D)



Gearheart, Marty (R)



Green, David (R)



Hall, Walter (R)



Hamilton, Anitra (D)



Hansen, Evan (D)



Heckert, Scot (R)



Hillenbrand, Rick (R)



Hite, Michael (R)



Holstein, Josh (R)



Hornbuckle, Sean (D)



Hornby, Michael (R)



Horst, Chuck (R)



Hott, John Paul (R)



Howell, Gary G. (R)



Howell, Tresa (R)



Jeffries, Dean (R)



Jennings, D. Rolland (R)



Jordan, John (R)



Kelly, Betsy (R)



Kimble, Laura (R)



Kump, Larry D. (R)



Kyle, Jonathan (R)



Leavitt, Tristan (R)



Lewis, Hollis (D)



Linville, Daniel (R)



Lucas, Patrick (R)



Mallow, Phil (R)



Marple, Keith (R)



Martin, Carl (R)



Masters, Ian (R)



Maynor, Jordan (R)



Mazzocchi, Margitta (R)



McCormick, David (R)



McGeehan, Pat (R)



Miller, George (R)



Moore, Erica (R)



Parsons, Joe (R)



Petitto, Mickey (R)



Phillips, Chris (R)



Pinson, Jonathan (R)



Pritt, David Elliott (R)



Pushkin, Mike (D)



Ridenour, William (R)



Riley, Clay (R)



Rohrbach, Matthew (R)



Roop, Carl (R)



Shamblin, Andy (R)



Sheedy, Charles (R)



Smith, Bryan (R)



Smith, Doug (R)



Statler, Joe (R)



Stephens, Jeffrey (R)



Street, George (R)



Toney, Christopher (R)



Vance, Adam (R)



Ward, Bryan (R)



Ward, Guy (R)



Watt, Gregory (R)



White, Lisa (R)



Williams, John (D)



Willis, Jimmy (R)



Worrell, Evan (R)



Young, Kayla (D)



Zatezalo, Mark (R)



House Clerk
Jeff Pack

PRECEDENCE OF MOTIONS

1. To adjourn.
2. To lay on the table.
3. For the previous question.
4. To limit debate.
5. To postpone to a day certain.
6. To go into a committee of the whole on the pending question.
7. To commit to a committee of the whole.
8. To commit to a standing committee.
9. To commit to a select committee.
10. To amend. [A motion to amend by striking out the enacting clause take precedence over another motion to amend.]
11. To postpone indefinitely.

MOTIONS - NOT DEBATABLE AND SHALL NOT BE AMENDED

1. To adjourn.
2. To fix the time of adjournment.
3. To lay on the table.
4. For the previous question.
5. To limit debate.
6. To dispense with Constitutional rule requiring bills to be read on three several days.
7. To recess.

REQUIRED VOTES

TO DISPENSE WITH CONSTITUTIONAL RULE requiring a bill to be read on three consecutive days. Requires a four-fifths vote by yeas and nays of all members present. [Const. Art. 6, Sec. 29]

TO MAKE A BILL EFFECTIVE FROM PASSAGE or at some time other than ninety days from passage, requires a two-thirds vote (67) by yeas and nays of all members elected. [Const. Art. 6, Sec. 30.]

YEA AND NAY VOTE may be demanded by one-tenth of members present.
[Rule 42.]

AN APPEAL FROM THE DECISION OF THE CHAIR may be demanded by 10 members. [Rule 6.]

MOTION FOR PREVIOUS QUESTION must be sustained by 10 members. [Rule 63.]

ORDER OF BUSINESS

Rule 65. The daily order of business shall be as follows:

- I.** To read, correct and approve the journal.
- II.** Introduction of guests.
- III.** To receive and consider reports of standing committees.
- IV.** To receive and consider reports of select committees.
- V.** To receive and consider messages from the Executive, state officials, and other communications and remonstrances.
- VI.** To receive messages from the Senate and consider amendments proposed by the Senate to bills passed by the House.
- VII.** To receive (a) resolutions, (b) petitions, (c) motions.
- VIII.** Bills introduced on motion for leave and referred to appropriate committees.
- IX.** To act on unfinished business of the preceding day and resolutions lying over from previous day, but no resolution shall lose its place on the calendar by not being acted upon on the day following that on which it was offered.
- X.** House and Senate Bills on third reading.
- XI.** House and Senate Bills on second reading.
- XII.** House and Senate Bills on first reading.
- XIII.** To act upon leave of absence for members.
- XIV.** Introduction of guests.
- XV.** Miscellaneous business.

HOUSE OF DELEGATES - LEADERSHIP

Speaker of the House:Roger Hanshaw
Majority Leader:Pat McGeehan
Majority Whip:Marty Gearheart
Speaker Pro Tempore, Deputy Speaker: Matthew Rohrbach
Deputy Speaker:Joe Ellington
Assistant Majority Leaders: David Elliott Pritt, David Green, Erica Moore, David McCormick,
Mickey Petitto
Assistant Majority Whips:Jordan Bridges, Eric Brooks, Jim Butler, Sarah Drennan, Dave Foggin,
Joe Funkhouser, Jonathan Pinson, Bill Ridenour
Minority Leader:Sean Hornbuckle
Minority Whip:Shawn Fluharty
Minority Leader Pro Tempore:Kayla Young
Deputy Minority Leader:Evan Hansen

HOUSE OF DELEGATES - STANDING COMMITTEES

Education

Joe Statler- Chair
Chris Toney - Vice Chair
Anitra Hamilton - Minority Chair
Rick Garcia - Minority Vice Chair
Bell, Campbell, Chiarelli, Coop-Gonzalez, Crouse, Dittman, Ellington, Hornby, Jennings, Kimble, Mallow, Miller, Parsons,
Pritt, Pushkin, Shamblin, Stephens, Vance, Ward, B., White, Willis

Educational Choice

Kathie Crouse - Chair
Mike Hornby - Vice Chair
Chiarelli, Kimble, Pritt, Pushkin, Shamblin, Statler, Stephens, White

Public Education

Jeff Campbell - Chair
Bell, Coop-Gonzalez, Ellington, Hamilton, Jennings, Miller, Stephens, Toney, Ward, B., Watt

Higher Education

Lori Dittman - Chair
Jimmy Willis - Vice Chair
Coop-Gonzalez, Garcia, Mallow, Miller, Parsons, Pritt, Vance, White

HOUSE OF DELEGATES - STANDING COMMITTEES

Energy and Public Works

Bill Anderson - Chair

Mark Zatezalo - Vice Chair

Evan Hansen - Minority Chair

Kayla Young - Minority Vice Chair

Bridges, Campbell, Crouse, Dillon, Eldridge, Fehrenbacher, Green, Hillenbrand, Holstein, Howell, Jordan, Kelly, Leavitt, Linville, Lucas, Moore, Parsons, Riley, Sheedy, Street, Ward, G.

Economic Development

Gary Howell - Chair

Campbell, Cannon, Green, Jordan, Kelly, Leavitt, Linville, Lucas, Moore, Parsons, Street, Young

Energy and Manufacturing

Bob Fehrenbacher - Chair

George Street - Vice Chair

Bridges, Crouse, Eldridge, Green, Hansen, Jordan, Moore, Parsons, Sheedy, Ward, G.

Environment, Infrastructure, and Technology

Daniel Linville - Chair

Rick Hillenbrand - Vice Chair

Bridges, Cannon, Dillon, Eldridge, Green, Hansen, Holstein, Kelly, Moore, Parsons

Finance

Vernon Criss - Chair

Clay Riley - Vice Chair

John Williams - Minority Chair

Sean Hornbuckle - Minority Vice Chair

Anderson, Cannon, Canterbury, Cooper, Dittman, Ellington, Fehrenbacher, Gearheart, Hall, Hite, Horst, Hott, Howell, Jeffries, Linville, Mazzocchi, Rohrbach, Statler, Toney, Worrell, Zatezalo

Appropriations

John Hott - Chair

Roy Cooper - Vice Chair

Anderson, Cannon, Fehrenbacher, Hornbuckle, Jeffries, Riley, Rohrbach, Zatezalo

Banking and Insurance

Walter Hall - Vice Chair

Ellington, Fehrenbacher, Hott, Jeffries, Linville, Riley, Rohrbach, Williams, Zatezalo

Investments

Jarred Cannon - Chair

Ray Canterbury - Vice Chair

Dittman, Gearheart, Hite, Hornbuckle, Horst, Statler, Toney, Worrell

HOUSE OF DELEGATES - STANDING COMMITTEES

Revenue

Marty Gearheart - Chair

Chuck Horst - Vice Chair

Canterbury, Dittman, Hall, Howell, Linville, Mazzocchi, Statler, Williams

Government Organization

Chris Phillips - Chair

Doug Smith - Vice Chair

Kayla Young - Minority Chair

Hollis Lewis - Minority Vice Chair

Adkins, Brooks, Browning, Burkhammer, Cannon, Clark, Clay, Dean, Drennan, Ferrell, Foggin, Hott, Howell, Kyle, Leavitt, Lucas, McCormick, Pinson, Sheedy, Smith, Street

Agriculture, Commerce, and Tourism

Patrick Lucas - Chair

David McCormick - Vice Chair

Adkins, Brooks, Browning, Clark, Foggin, Kyle, Lewis, Smith

Government Administration

Jonathan Pinson - Chair

Mark Dean - Vice Chair

Brooks, Browning, Clay, Foggin, Howell, Kyle, Leavitt, McCormick, Smith, Young

Local Governments

Dana Ferrell - Chair

Charles Sheedy - Vice Chair

Adkins, Brooks, Browning, Burkhammer, Clay, Drennan, Foggin, Howell, Kyle, Leavitt, McCormick, Young

Health and Human Resources

Evan Worrell - Chair

Michael Hite - Vice Chair

Mike Pushkin - Minority Chair

Anitra Hamilton - Minority Vice Chair

Amos, Anders, Burkhammer, Chiarelli, Clark, Dean, Drennan, Hall, Heckert, Jeffries, Lewis, Mazzocchi, Miller, Petitto, Pinson, Rohrbach, Smith, Stephens, Vance, Watt, Willis

Health Care Regulation

Dean Jeffries - Chair

Adam Vance - Vice Chair

Amos, Anders, Chiarelli, Clark, Drennan, Lewis, Masters, Smith, Watt

Human Services

Adam Burkhammer - Chair

Margitta Mazzocchi - Vice Chair

Hall, Hamilton, Heckert, Hite, Miller, Petitto, Pinson, Willis

HOUSE OF DELEGATES - STANDING COMMITTEES

Public Health

Scot Heckert - Chair

Geno Chiarelli - Vice Chair

Amos, Anders, Dean, Drennan, Masters, Miller, Petitto, Pushkin

Judiciary

James Akers - Chair

Jordan Maynor - Vice Chair

Shawn Fluharty - Minority Chair

Evan Hansen - Minority Vice Chair

Butler, Cannon, D., Ferrell, Flanigan, Funkhouser, Heckert, Hillenbrand, Holstein, Hornby, Jennings, Kimble, Kump, Mallow, Marple, Martin, Masters, Phillips, Ridenour, Roop, Shamblin, Ward, B.

Courts

Phil Mallow - Chair

Andy Shamblin - Vice Chair

Cannon, D., Flanigan, Fluharty, Funkhouser, Marple, Roop, Ward, B.

Homeland Security

D. Jennings - Chair

Bryan Ward - Vice Chair

Butler, Ferrell, Funkhouser, Hansen, Heckert, Hillenbrand, Phillips, Ridenour

Legal Services

Laura Kimble - Chair

Josh Holstein - Vice Chair

Butler, Flanigan, Fluharty, Hornby, Marple, Maynor, Ridenour, Roop

Rules

Roger Hanshaw - Chair

Pat McGeehan - Vice Chair

Akers, Anderson, Criss, Ellington, Gearheart, Hornbuckle, Hornby, Hott, Howell, Jeffries, Linville, Phillips, Riley, Rohrbach, Statler, Toney, Worrell, Young

HOUSE CHAMBER SEATING CHART

Doorkeeper
Robert Stewart

Sergeant at Arms
Ed Hart

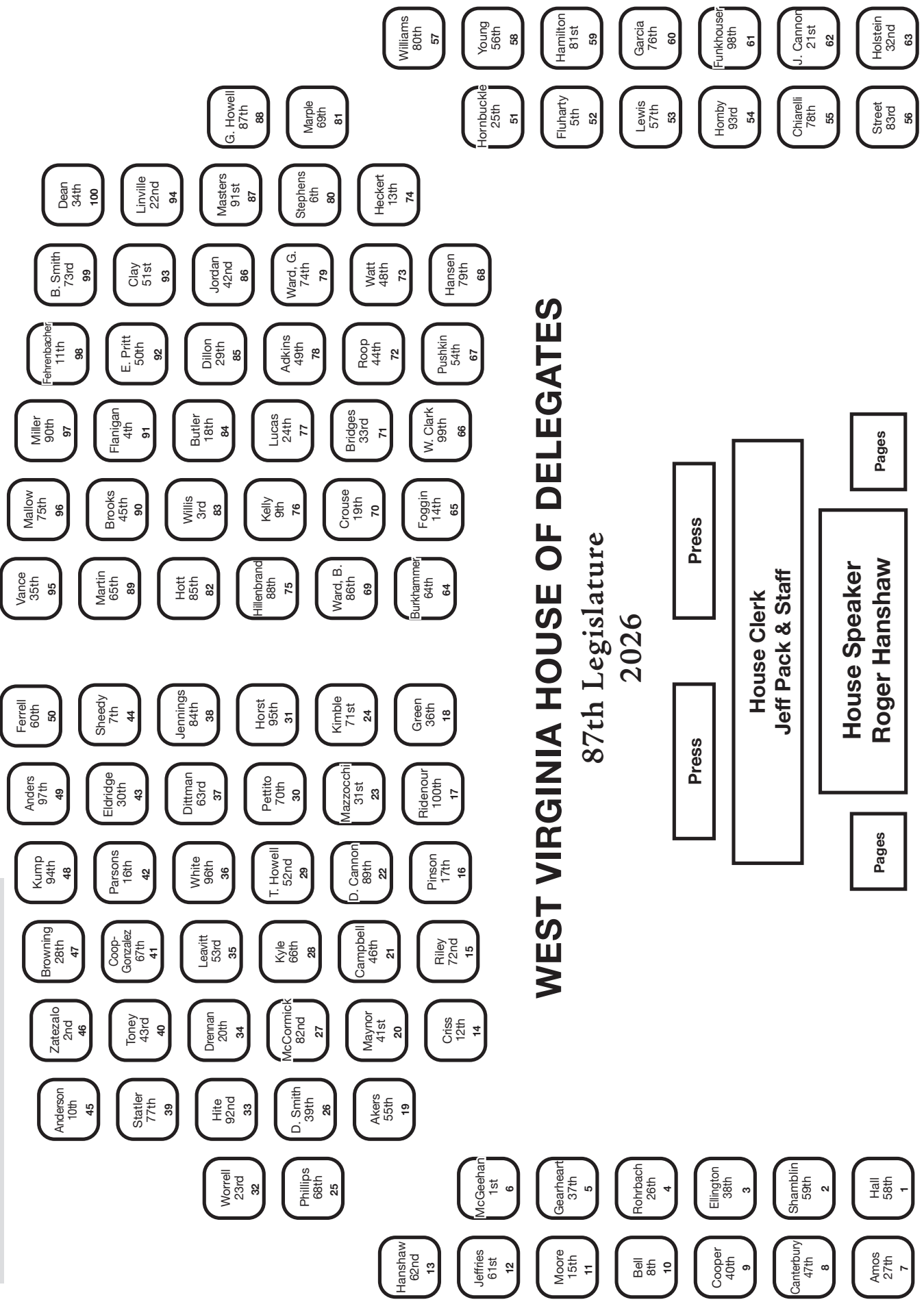

WEST VIRGINIA HOUSE OF DELEGATES

87th Legislature
2026

Press

Press

House Clerk
Jeff Pack & Staff

Pages

House Speaker
Roger Hanshaw

Pages

CAPITOL MAPS



WEST VIRGINIA STATE CAPITOL MAPS

Main Building - Basement

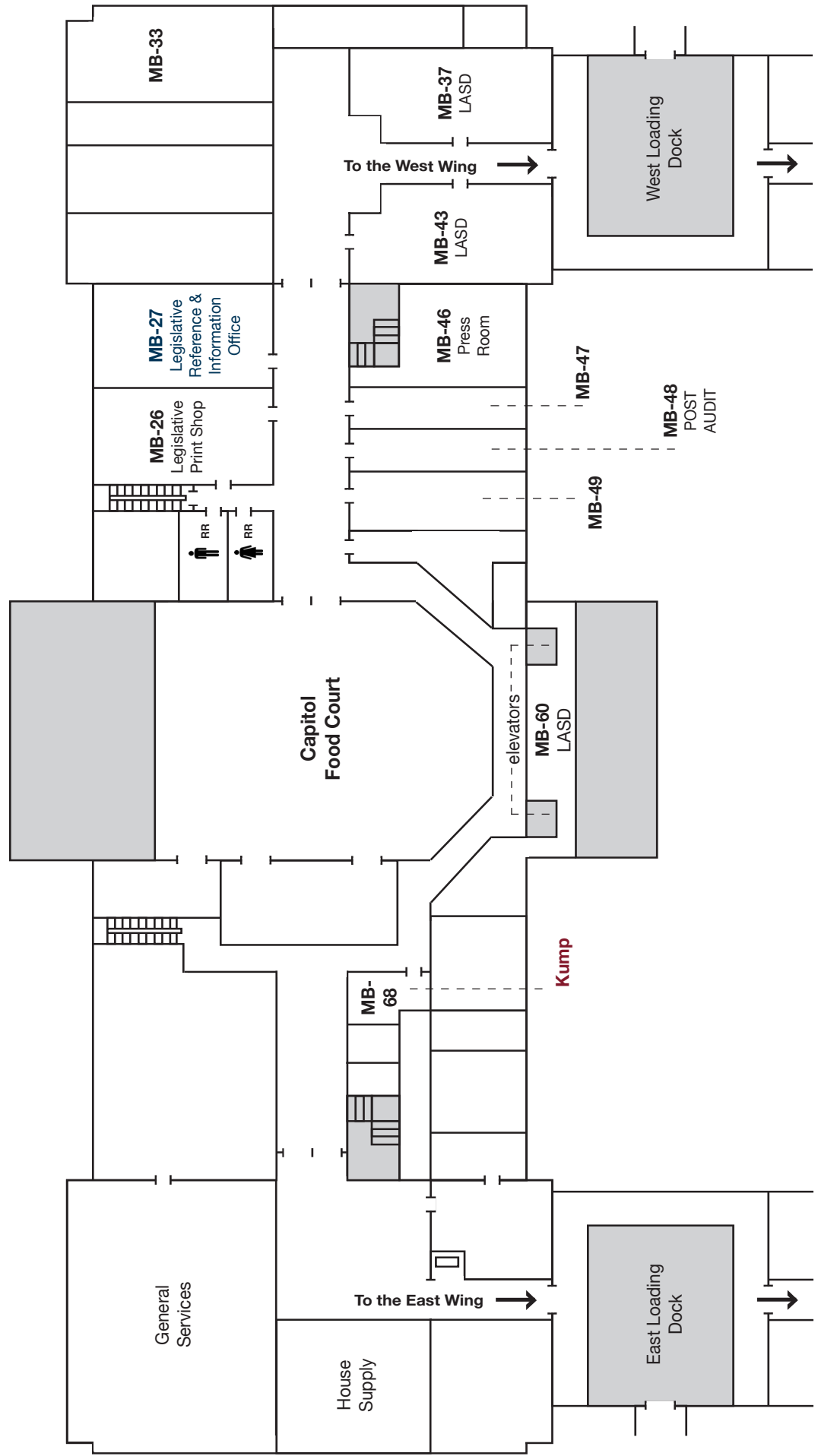
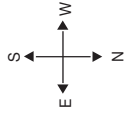

WEST VIRGINIA STATE CAPITOL MAPS

Main Building - Second Floor

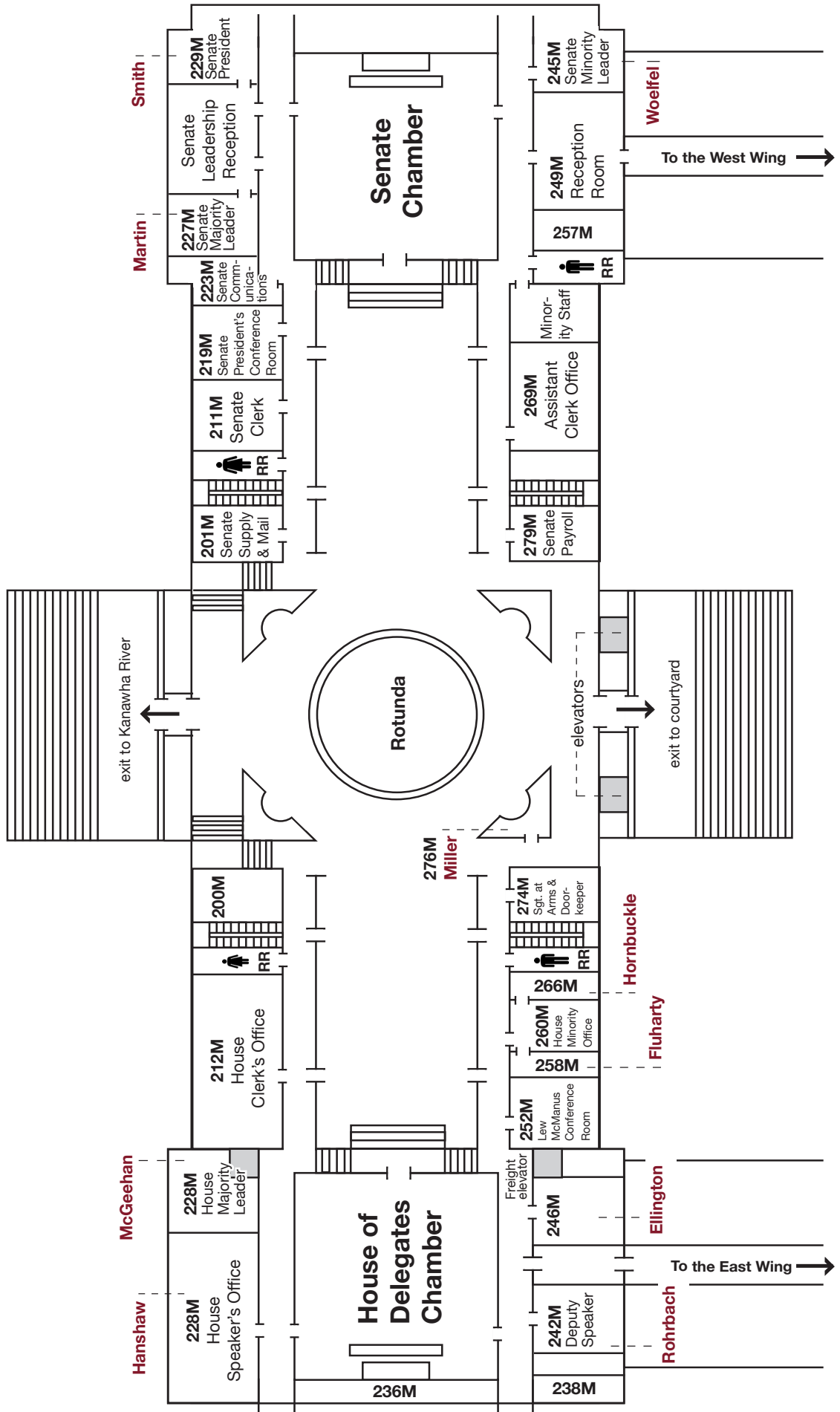
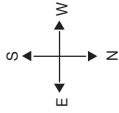

WEST VIRGINIA STATE CAPITOL MAPS

Main Building - Third Floor

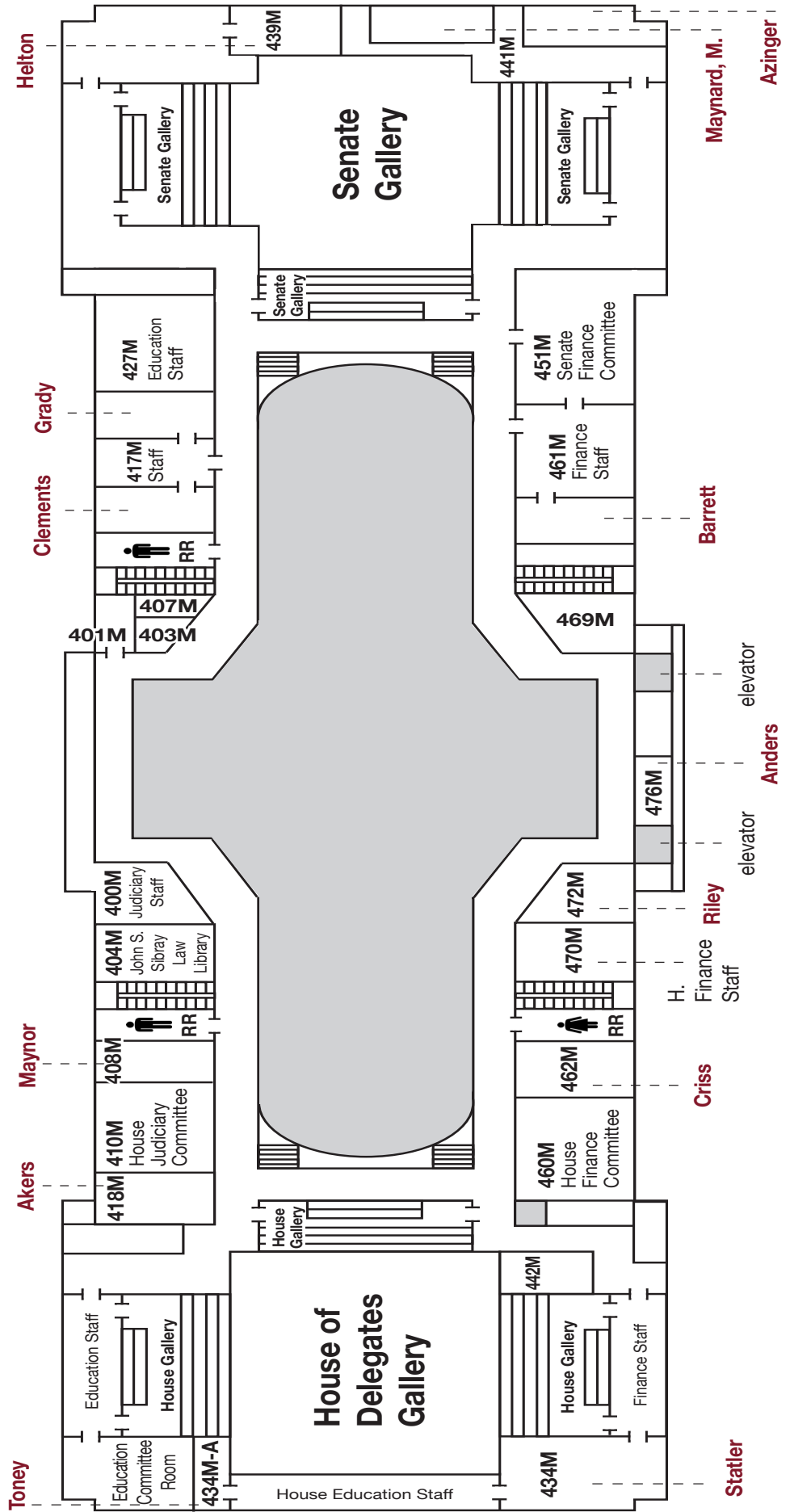
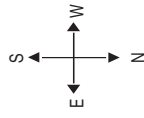

WEST VIRGINIA STATE CAPITOL MAPS

West Wing - Second Floor - Senate

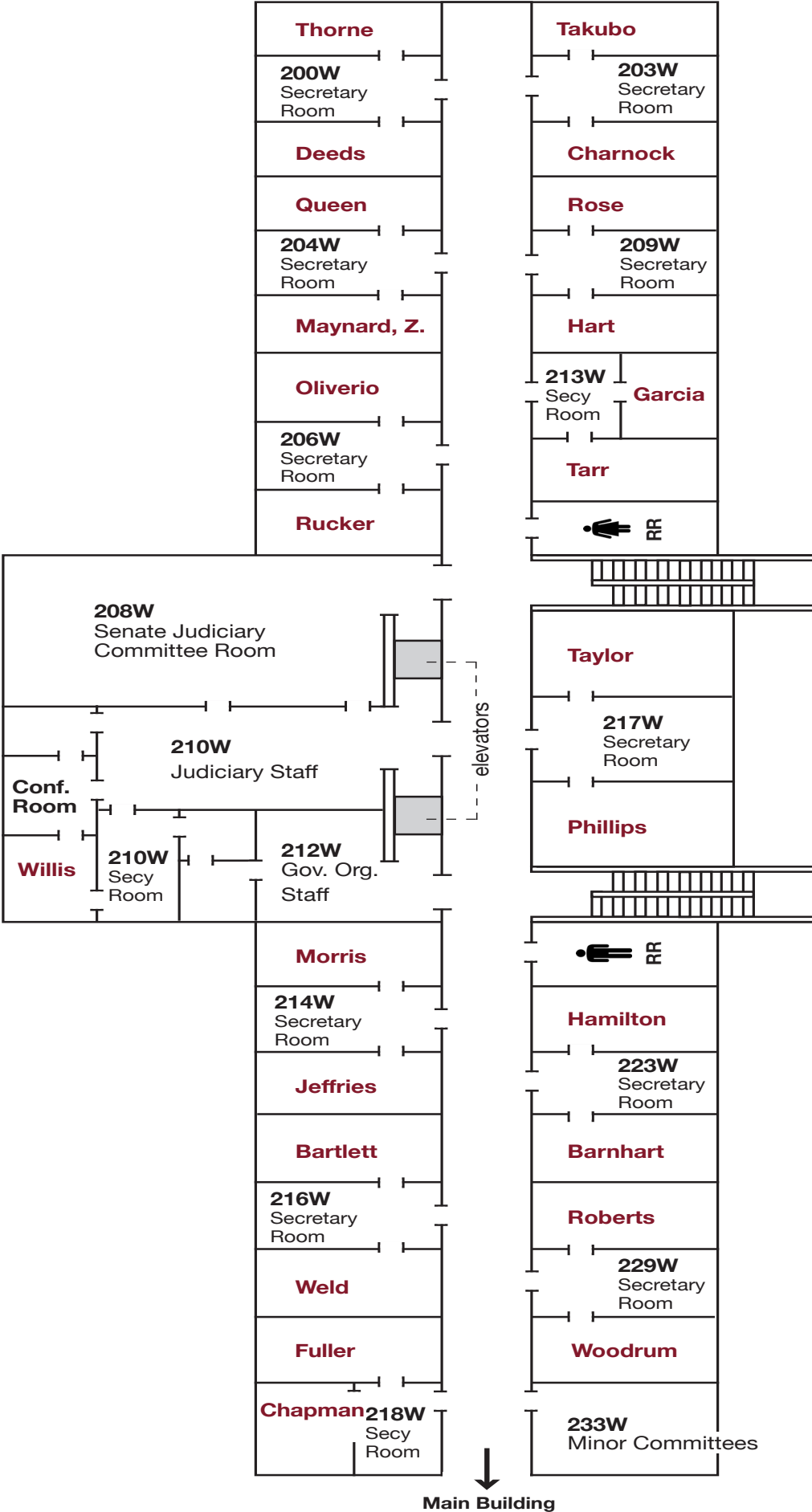
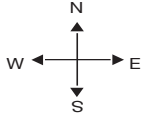

WEST VIRGINIA STATE CAPITOL MAPS

East Wing - Second Floor - House of Delegates

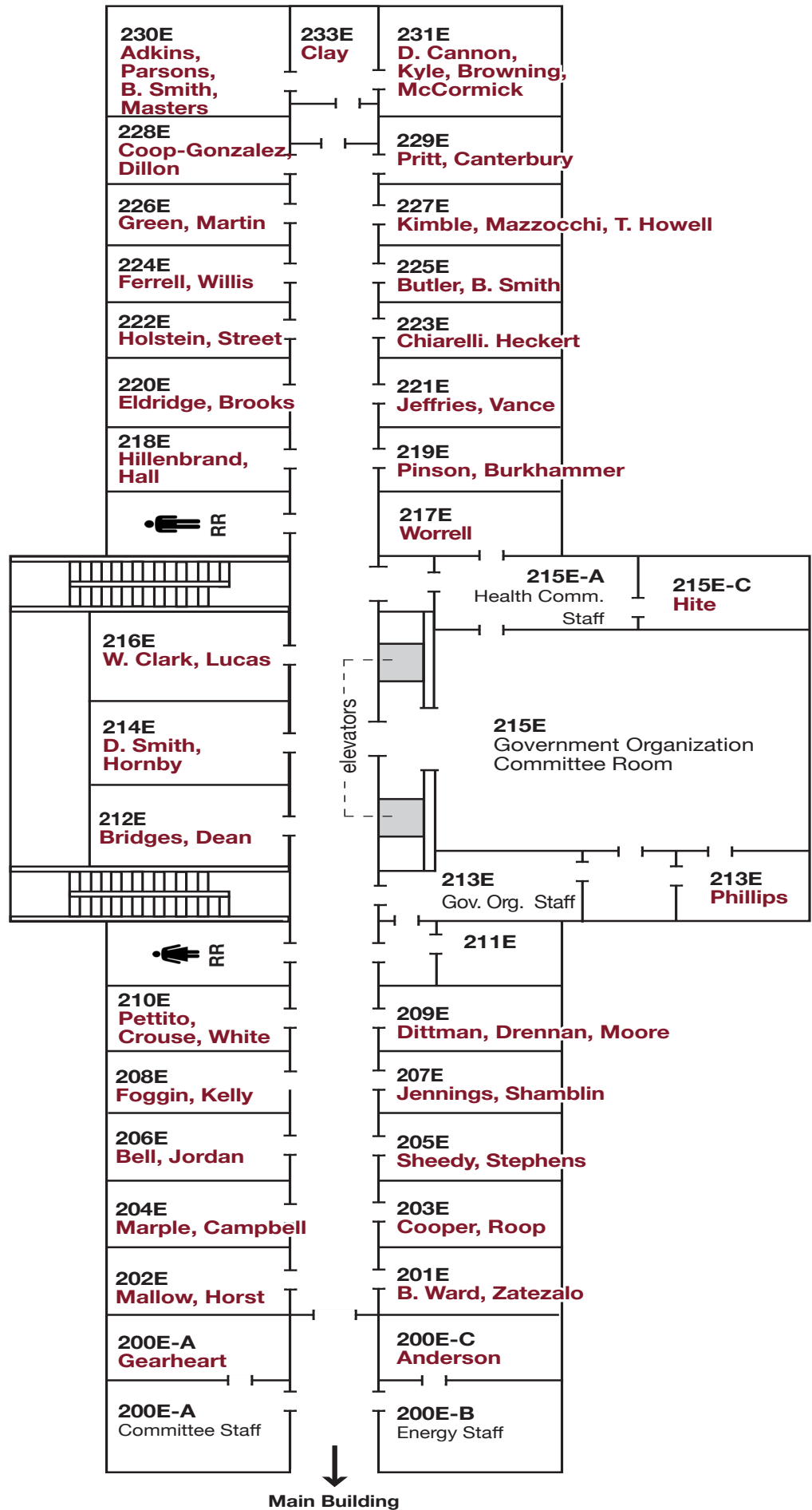
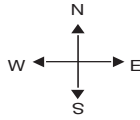

SENATORS BY DISTRICT & SENATE DISTRICT MAP - 2020 PLAN

Senate District - 01
 Laura Wakim Chapman (R - Ohio)
 Ryan W. Weld (R - Brooke)

Senate District - 02
 Chris Rose (R - Monongalia)
 Charles H. Clements (R - Wetzel)

Senate District - 03
 Michael T. Azinger (R - Wood)
 Trenton Barnhart (R - Pleasants)

Senate District - 04
 Amy N. Grady (R - Mason)
 Eric J. Tarr (R - Putnam)

Senate District - 05
 Michael A. Woelfel (D - Cabell)
 Scott Allen Fuller (R - Wayne)

Senate District - 06
 Mark R. Maynard (R - Wayne)
 Craig A. Hart (R - Mingo)

Senate District - 07
 Rupie Phillips (R - Logan)
 Zach Maynard (R - Lincoln)

Senate District - 08
 Glenn D. Jeffries (R - Putnam)
 T. Kevan Bartlett (R - Kanawha)

Senate District - 09
 Brian Helton (R - Fayette)
 Rollan A. Roberts (R - Raleigh)

Senate District - 10
 Jack David Woodrum (R - Summers)
 Vince Deeds (R - Greenbrier)

Senate District - 11
 Bill Hamilton (R - Upshur)
 Robbie Morris (R - Randolph)

Senate District - 12
 Patrick S. Martin (R - Lewis)
 Ben Queen (R - Harrison)

Senate District - 13
 Joey Garcia (D - Marion)
 Michael A. Oliverio (R - Monongalia)

Senate District - 14
 Jay Taylor (R - Taylor)
 Randy E. Smith (R - Preston)

Senate District - 15
 Darren Thorne (R - Hampshire)
 Tom Willis (R - Berkeley)

Senate District - 16
 Jason Barrett (R - Berkeley)
 Patricia Puertas Rucker (R - Jefferson)

Senate District - 17
 Tom Takubo (R - Kanawha)
 Anne B. Charnock (R - Kanawha)

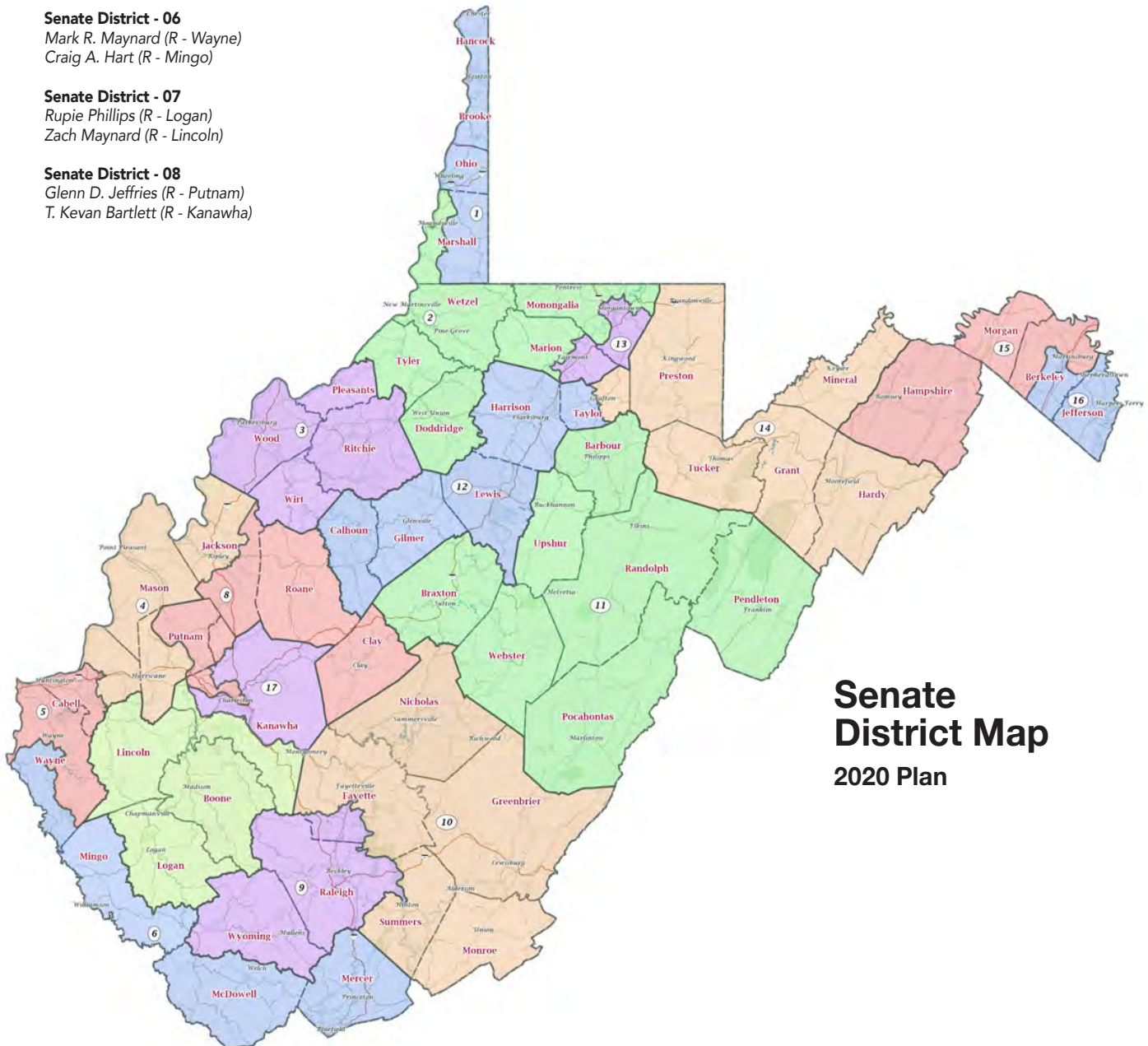

Senate District Map
 2020 Plan

HOUSE OF DELEGATES DISTRICT MAP - 2020 PLAN

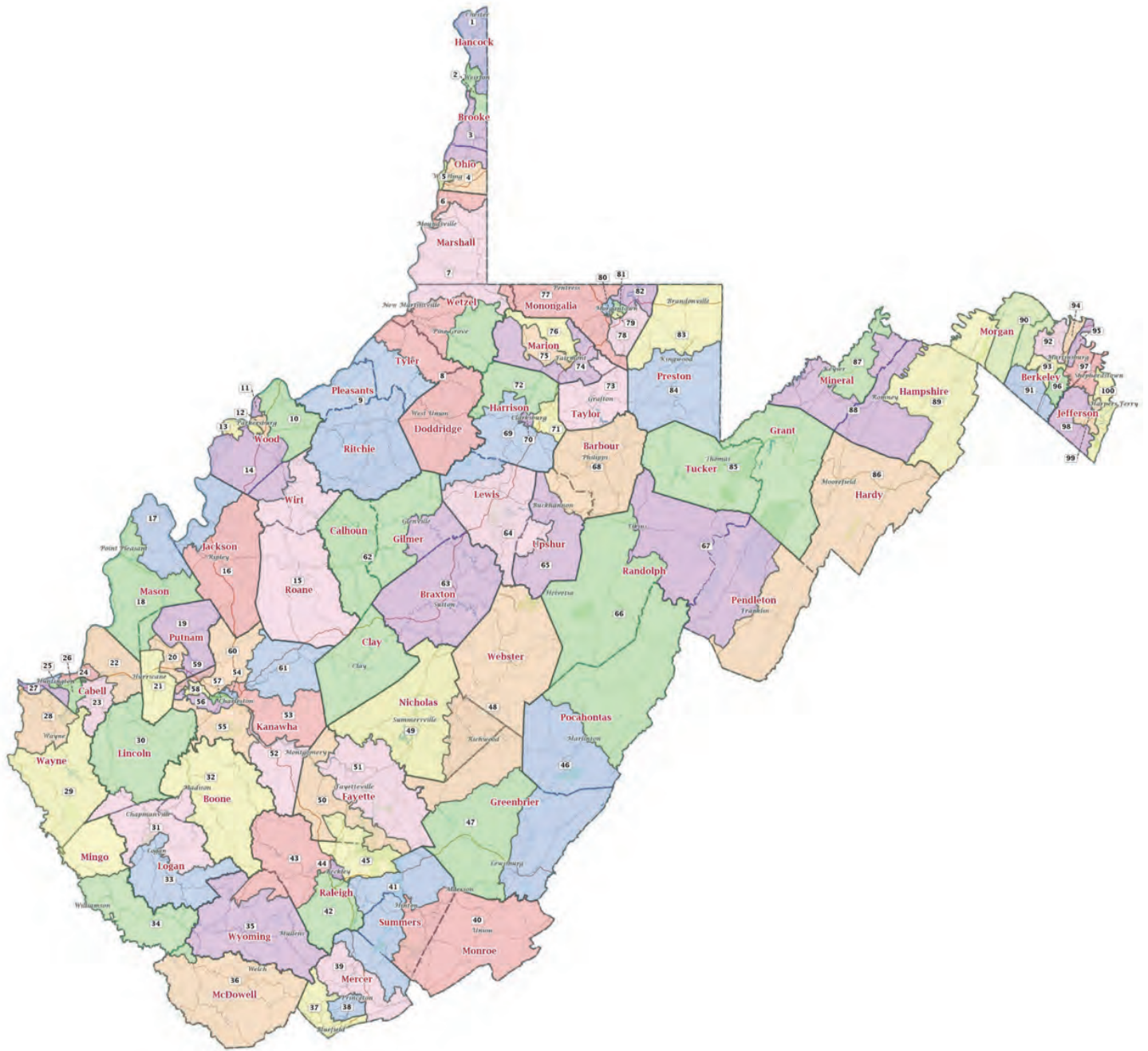

CONGRESSIONAL DISTRICTS

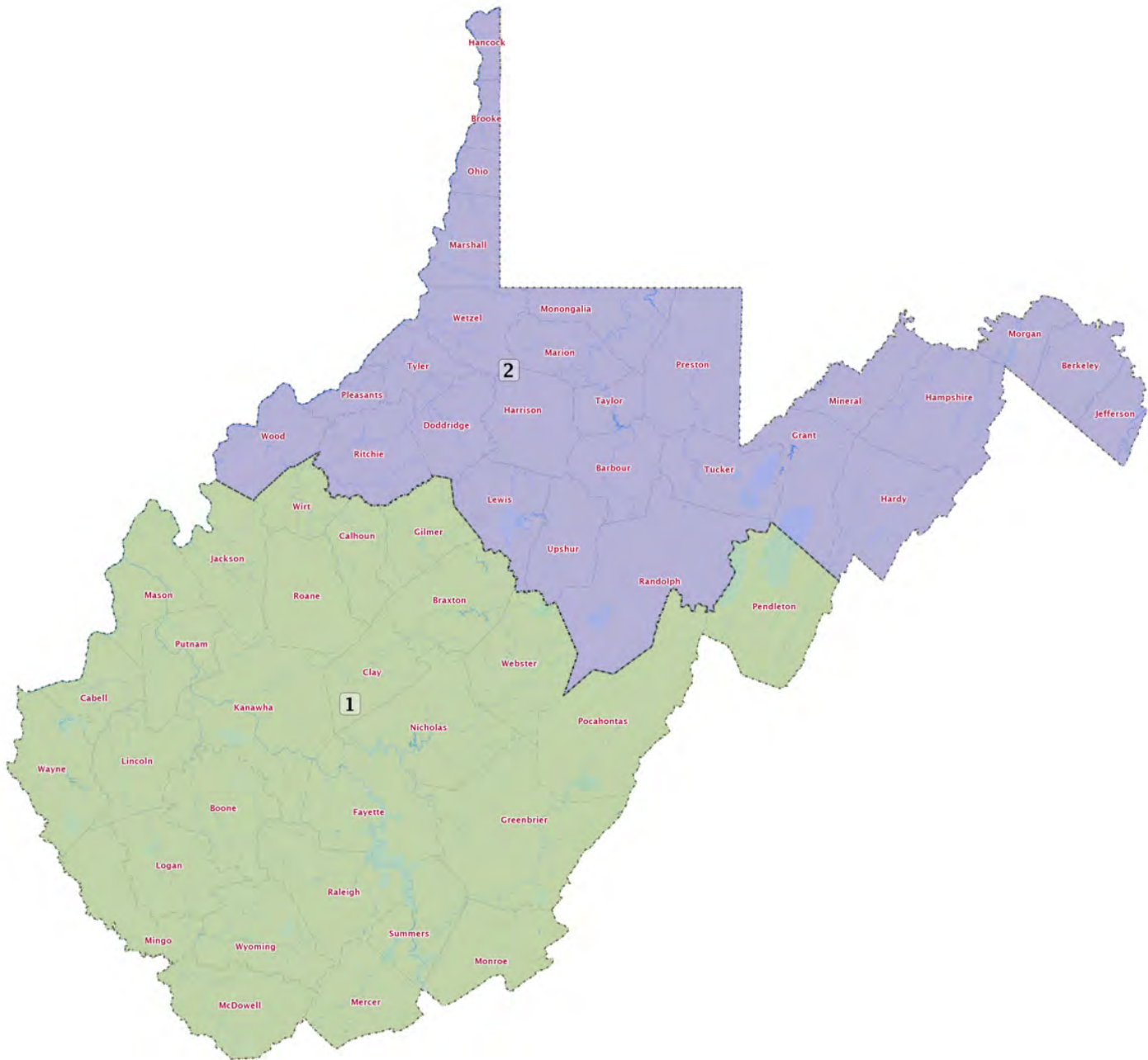

1st District
The Honorable Carol Miller
U.S. House of Representatives

2nd District
The Honorable Riley Moore
U.S. House of Representatives

STATE GOVERNMENT



STATE OF WEST VIRGINIA ORGANIZATIONAL CHART

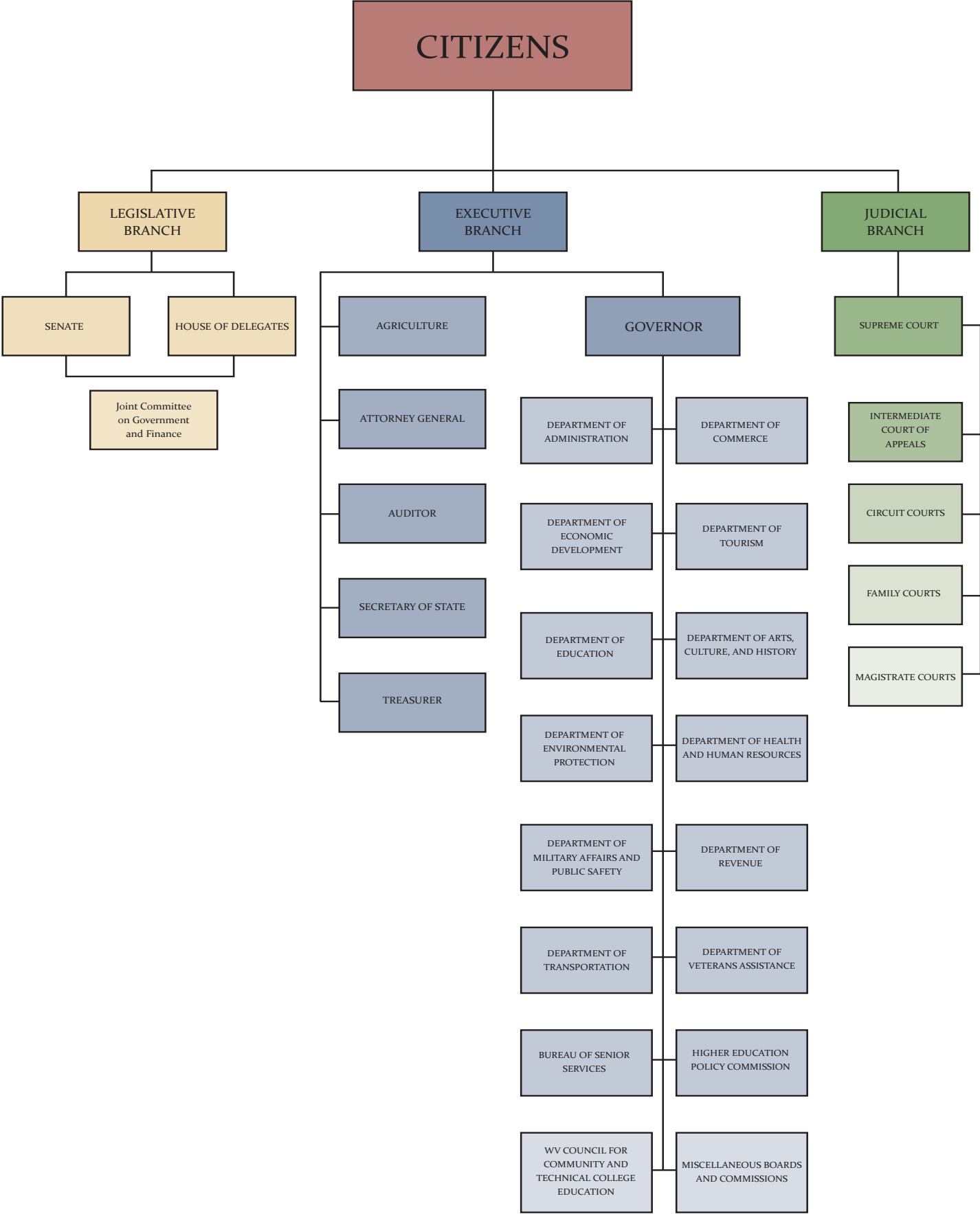

WV LEGISLATIVE PROCESS



A bill is introduced by a member of the House or Senate



It is referred to a committee by the House Speaker or the Senate President



The committee considers the bill



It is read a third time, members debate and then vote on the bill



It is read a first time, advanced to second reading, and possibly amended



The committee reports the bill to the members of the House or Senate



If passed, the bill is sent to the second chamber where the process repeats



with the Speaker or the President...

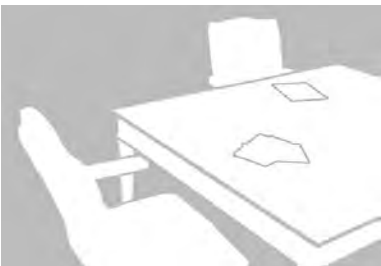

the committee...



The Legislature may vote to override the veto, and the bill becomes law without the Governor's approval



If passes, the bill is signed into law or vetoed by the Governor



and action by the House or Senate...

LEGISLATIVE GLOSSARY

adjournment — termination or closing of a session of the Legislature or committee until another set time.

adjournment sine die — final adjournment of legislative body, adjournment without a day and time set.

adoption — approval or acceptance; usually applied to amendments, resolutions and motions.

amendment — changes in legislation by adding, deleting or modifying material.

appropriation — money allocated by the Legislature to various departments or agencies for their operation.

bill — a proposal for a new law, the amendment or repeal of an existing law, or appropriation of public money.

calendar — listing of bills and resolutions reported out of committee.

Clerk — chief administrative officer of the Senate elected by the members. The Clerk is the custodian of the official records, charged with keeping the Journal and supervises the clerical business of the Senate.

committee reports and recommendations — committee reports and recommendations are advisory only.

division — a method of voting in which only the numerical result is recorded.

enacting clause — that clause of a bill or of an act that formally expresses the legislative sanction.

engrossed bill — version of bill that includes all adopted amendments of house of origin attached in the original measure.

enrolled bill — final official version of bill as agreed to by both houses, containing all necessary signatures.

germaneness — the relevance or appropriateness of amendments or substitutes.

lay over — postponement of consideration of a legislative matter.

motion — a proposal made to the presiding officer calling for special action. The principal tool used in the transaction of legislative business. Motions are of various order, rank, precedence and class as established through parliamentary practice and rules.

point of order — question raised by a member when he or she doubts the correctness of a procedure being followed. Such a point requires a ruling from the presiding officer, is not debatable and is subject to appeal to the house in which the point of order is raised.

President — presiding officer of the Senate elected by Senate members.

reconsider — a motion to retake a vote which places the question in the same status it was prior to the vote on the question.

resolution — measure used by single house to take action affecting its own procedure or expressing an opinion.

concurrent — measure affecting actions or procedures of both houses.

joint — measure used to propose amendments to the State Constitution or to ratify amendments to the United States Constitution. Action by both houses is required.

second reading — reading of bill or joint resolution by reading clerk at a regularly scheduled session, usually having already been acted upon by a standing committee. The measure may be amended on the floor at this time.

Speaker — presiding officer of the House of Delegates elected by House members.

strike out — used in amendments to bills and resolutions in order to delete unwanted language. A motion to strike out the enacting clause has the effect of killing the bill.

substitute — a substitute bill replaces the original measure.

suspend the rules — a motion which temporarily suspends the normal rules of procedure to accommodate the handling of a particular measure. Only that matter for which suspensions took place can be considered.

third reading — reading of bill or joint resolution by reading clerk at a regularly scheduled session for passage by either house.

title — a concise statement of the contents of a bill.

short title — an abridged description of a bill.

unanimous consent — permission granted without objection by either house to a member desiring to accomplish a measure without making a motion.

unfinished business — business which has been laid over from a previous day.

veto — the action of the Governor in disapproving a legislative measure.

voice vote — oral expression of the members when a question is submitted for their determination. Vote, division and rising-to vote by standing. Numerical results only are recorded in division.

withdraw a motion — a request to retract from further consideration a motion already offered.

yeas and nays — recorded vote of members on an issue.

ELECTED OFFICES

EXECUTIVE OFFICES

These six elected state officers, along with the appointed state superintendent of schools, comprise the Board of Public Works. Each shares a portion of the responsibility of leading, directing and administering state government operations and carrying out laws adopted by the Legislature. Their separate duties create a balance of power within the executive branch.

All candidates for these offices file with the Secretary of State and appear on the ballot in all 55 counties. Each candidate must be a qualified voter — which simply means the candidate must be eligible to register to vote in West Virginia. Other qualifications are listed.

GOVERNOR

Term 4 years
Salary \$150,000
Filing Fee \$1,500
Minimum Age 30 years
Residence WV 5 years preceding elections
(Maximum 2 consecutive terms)

ATTORNEY GENERAL

Term 4 years
Salary \$95,000
Filing Fee \$950
Minimum Age 25 years
Residence WV 5 years preceding elections

AUDITOR

Term 4 years
Salary \$95,000
Filing Fee \$950
Minimum Age 18 years
Residence WV

COMMISSIONER OF AGRICULTURE

Term 4 years
Salary \$95,000
Filing Fee \$950
Minimum Age 18 years
Residence WV
(Agriculture chief/business 10 years before election)

SECRETARY OF STATE

Term 4 years
Salary \$95,000
Filing Fee \$950
Minimum Age 18 years
Residence WV

TREASURER

Term 4 years
Salary \$95,000
Filing Fee \$950
Minimum Age 18 years
Residence WV

LEGISLATIVE OFFICES

STATE SENATE

Term 4 years

Salary \$20,000

Filing Fee \$200

Minimum Age 25 years

Residence WV 5 years.

District and county 1 year

(In multi-county districts, no more than one elected or serving from a county)

Seventeen of the thirty-four seats in the State Senate will be up for election to a full term every two years.

HOUSE OF DELEGATES

Term 2 years

Salary \$20,000

Filing Fee \$100

Minimum Age 18 years

Residence District (and county, if limited) 1 year

(See Residence limits below)

All one hundred of the seats in the House of Delegates are on the ballot every two years in even numbered years. Eligible candidates from any area may file. Before filing, be sure to know your district number. Your county clerk can help you if you live close to a boundary.

JUDICIAL OFFICES

JUSTICE OF THE SUPREME COURT OF APPEALS

Term 12 years

Salary \$142,800

Filing Fee \$1,210

Minimum Age 30 years

Residence WV 5 years

(Admitted to practice law 10 years before election)

The Supreme Court of the Appeals is West Virginia's highest court and the court of last resort. West Virginia is one of only 11 states with a single appellate court. The Supreme Court of Appeals of West Virginia is the busiest appellate court of its type in the United States.

There are two terms of the Court each year. The first terms begin on the second Tuesday in January and ends in July. The second term begins on the first Wednesday in September and ends in December.

INTERMEDIATE COURT OF APPEALS

Term 10 years

Salary \$142,500

Filing Fee \$200

Minimum Age None (Must have practiced law in WV for 10 years and be a member of the State Bar)

Residence WV 5 years

(Signed into law April 9, 2021 by the passing of SB 275 RS)

BUDGET



THE BUDGET PROCESS

This section is an overview of the Legislative (Senate and House of Delegates) and Executive (Governor) processing of the state budget before it becomes law.

Every citizen of West Virginia is affected by the budget many times in each fiscal year. It is the single most important bill passed by the Legislature. This bill does not contain power of taxation. However, it is the regulatory device which determines the taxes West Virginians will pay. It determines the level of services the people will receive in any given fiscal year that begins July 1 and expires June 30.

An interesting comparison in the preparation of the budget bill with an individual's personal budgeting process gives a better understanding as demonstrated in the following examples:

- Determining essential services
- Financial need for growth
- Availability of finances to meet services and expenses
- Risk involved in determining if new taxes will be assessed

WHERE THE STATE DOLLAR COMES FROM

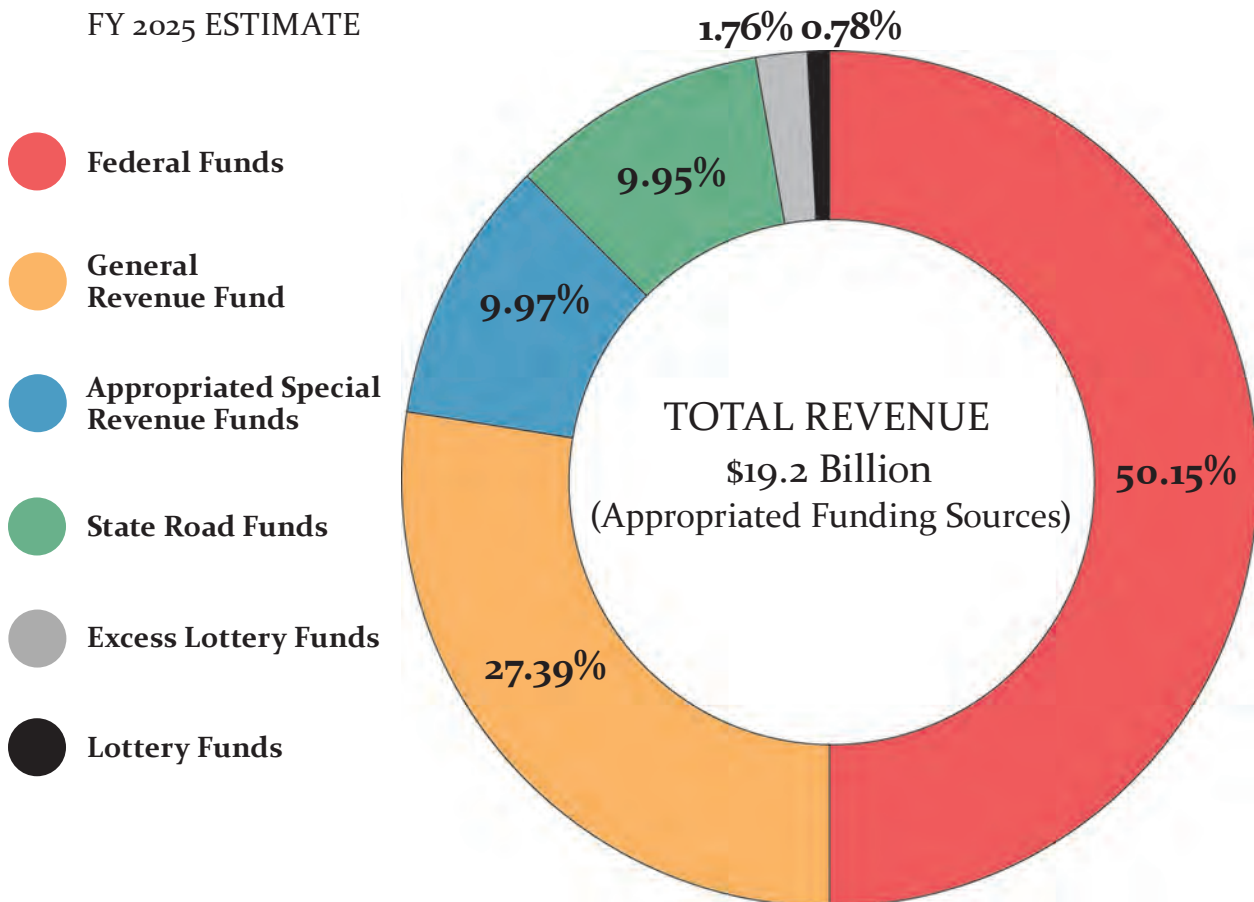

WHERE THE STATE DOLLAR GOES

FY 2025 ESTIMATE

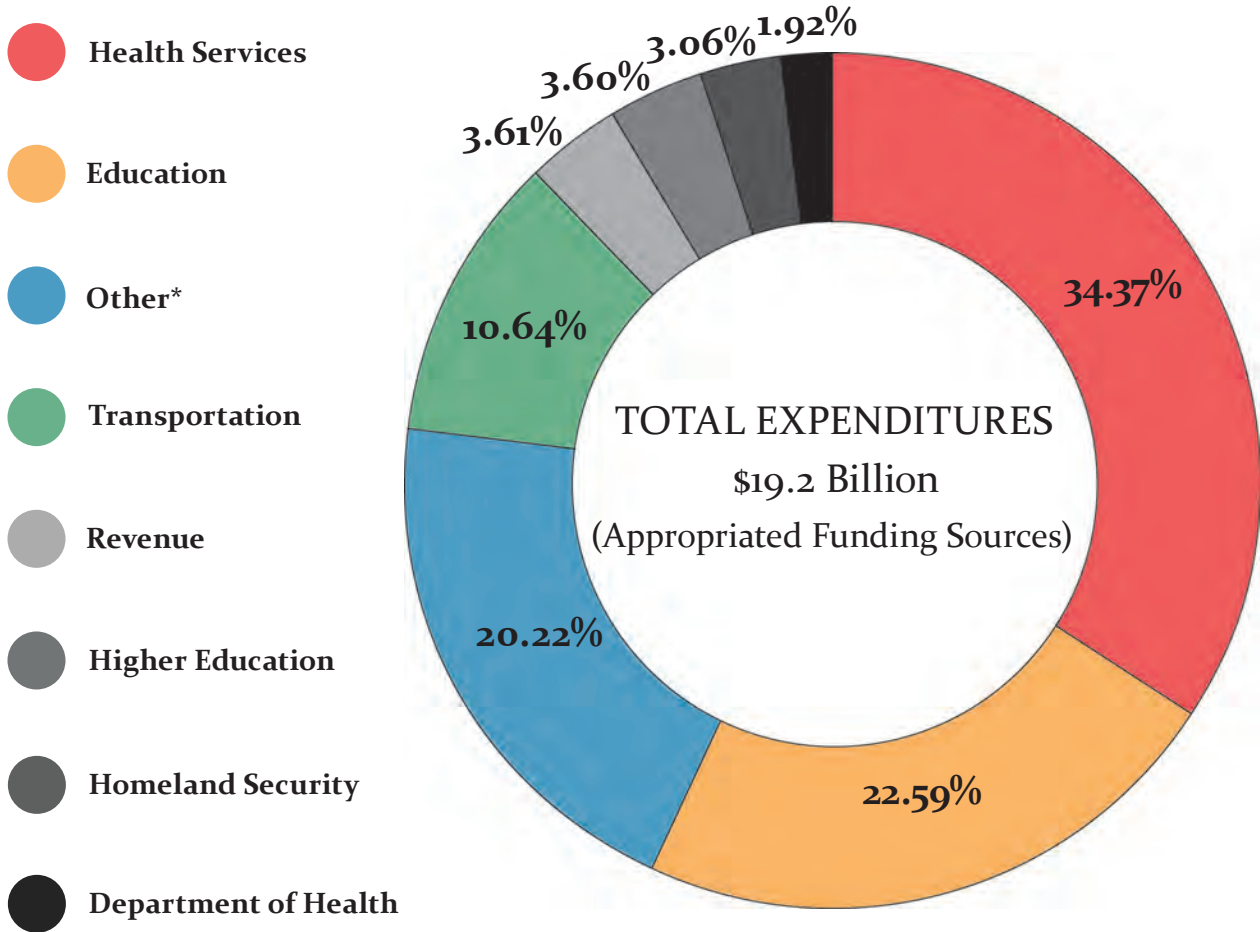

- Other*
- Arts, Culture, and History 0.23%
- Commerce 1.85%
- Economic Development 7.03%
- Environment 2.81%
- Executive 1.50%
- Judicial 0.86%
- Legislature 0.18%
- Misc. Boards & Commissions 1.48%
- Seniors 0.51%
- Tourism 0.17%
- Veterans' Assistance 0.28%

BUDGET OVERVIEW

The Constitution of West Virginia requires the Governor to submit a proposed budget to the Legislature on the second Wednesday of January each year, except the year following a regular gubernatorial election, at which time the budget is to be submitted on the second Wednesday of February.

BUDGET PROCESS CALENDAR

1. Issue appropriation request guidelines (**July**)
2. Agencies submit requests (**September**)
3. State Budget Office reviews requests (**September**)
4. State Budget Office hearings with State Agencies (**September-October**)
5. Official revenue estimates completed (**November**)
6. *Final budget recommendations (**December**)
7. *Governor presents proposed budget to Legislature (**January**)
8. *Legislative Budget Hearings with state agencies (**January-February**)
9. *House Finance Bill
Senate Finance Bill
10. *Legislature passes budget (**March**)
11. *Governor approves or vetoes (**March**)
12. Issue expenditure schedule guidelines (**April**)
13. Agencies submit expenditure schedules (**May**)
14. State Budget Office reviews schedules (**May-June**)
15. Revenue Cabinet Secretary approves (**June**)
16. Schedules entered into WV Financial Information Management System (**June**)
17. Appropriations are ready for agencies to process payments when fiscal year begins July 1.

**Following a regular gubernatorial election, these steps in the budget process are delayed by one month.*

MAJOR STATUTORY AND NONDISCRETIONARY REQUIREMENTS

Each year there are several major nondiscretionary requirements that limit the flexibility of any discretionary recommendations by the Governor. The FY 2016 Executive Budget recommendations include expenditures of \$2.8 billion of these major requirements and make up 65% of the total General Revenue funds available.

Items that fall in the discretionary spending category, which make up 35% of the total General Revenue funds available, are considered necessary for public health, safety, and education of West Virginia citizens and may include but are not limited to: Division of Corrections, West Virginia State Police, Behavioral Health, Rehabilitation Services, Children's Health Insurance Program, Schools for the Deaf and Blind and Higher Education that supports public universities and colleges and provides student financial aid.

MOTOR FUEL TAXES

Motor Fuel Excise Tax

- Contains a flat rate and a variable rate.
- Current flat rate is \$.205 per gallon.
- Variable rate is equal to five percent of the average wholesale price of motor fuel.
- Imposed and payable on all motor fuel upon import into this state, removal from a terminal within this state, or removal from a terminal in another state for delivery in this state.
- The average wholesale price shall not be less than \$2.34 per gallon, which generates a minimum tax rate of \$0.142 per gallon.
- By December 1st of each year, the tax commissioner must calculate the average wholesale price and variable rate from sales data from the previous July through October. Calculated rate is effective for the next calendar year. The calculated price and calculated rate may not deviate by more than ten percent from the prior year.

Motor Carrier Road Tax

- Equivalent to the Motor Fuel Excise Tax on motor fuel.
- Imposed upon every motor carrier with a vehicle that is designed to transport persons or property having two or more axles with a gross vehicle weight exceeding 26,000 pounds, including road tractors and tractor trucks.
- Based upon each gallon of motor fuel used in the carrier's operations in the state.
- Carrier is entitled to a refund for fuel purchased in the state but used out of state.
- Carriers domiciled in the state are charged an annual fee of \$10 for two identification markers.

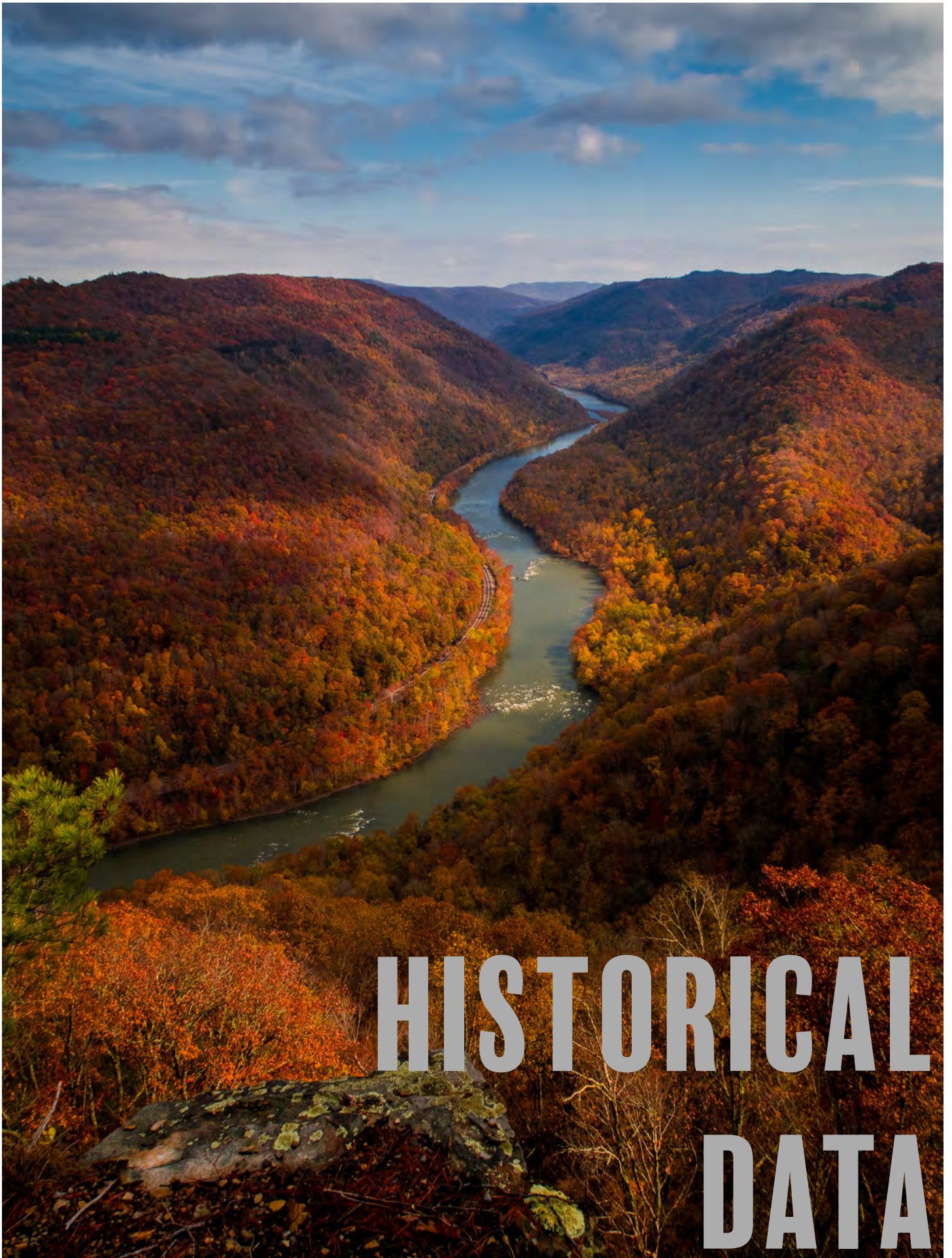

**HISTORICAL
DATA**

STATE PROFILE

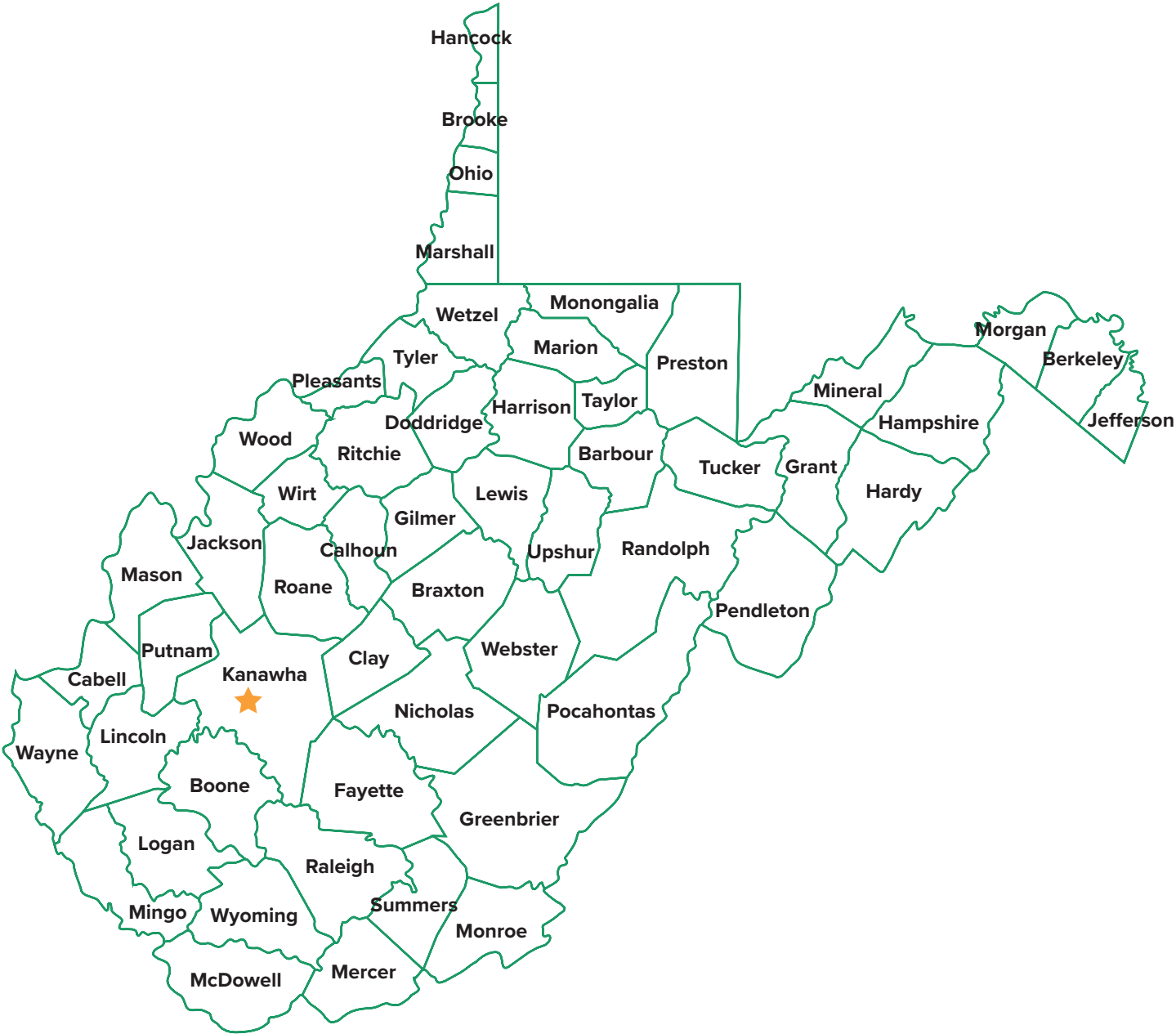

GEOGRAPHICAL DATA

Area 24,231.4 mi²
Counties 55
Municipalities 234
Senatorial Districts 17
Delegate Districts 100
Congressional Districts 2
Judicial Circuits 31
Members of the House of Delegates 100
Members of the Senate 34

State Capitol Charleston, Kanawha County
Youngest county Mingo (1895)
Oldest county Hampshire (1754)
Smallest county Hancock (88.2 mi²)
Largest county Randolph (1,040 mi²)
Highest point Spruce Knob (4,861 ft)
Lowest point Harper's Ferry (247 ft)
Geographical center near Sutton, Braxton County
Population center near Gassaway, Braxton County

HISTORY

People have lived in West Virginia as far back as 12,500 years ago, beginning with the Paleo-Indians. The Fort Ancient Indians inhabited the area until 300 years ago when they were driven out by the Iroquois Indians from New York and the Great Lakes area. When the first European settlers arrived, all the Native American villages were gone, and the area was a hunting ground used by many tribes including the Cherokee, Shawnee, and Iroquois.

The first permanent European settlement dates from 1731 when Morgan Morgan founded Mill Creek. In 1742 coal was discovered on the Coal River, an event that would be of great significance in determining West Virginia's future.

West Virginia shares its history with Virginia from 1601 to 1861. Then the delegates of 40 western counties formed their own government, which was granted statehood in 1863. Declared a state by President Abraham Lincoln, West Virginia is the only state designated by a Presidential Proclamation.

STATE FLAG



By Senate Joint Resolution Number 18, approved by the Legislature March 7, 1929, West Virginia adopted the present State flag. The resolution in part is as follows: "That the Legislature of West Virginia hereby adopts a State flag of the following design and proportions, to-wit:

The proportions of the flag of the State of West Virginia shall be the same as those of the United States ensign; the field shall be pure white, upon the center of which shall be emblazoned in proper colors, the coat-of-arms of the State of West Virginia upon which appears the date of the admission of the State into the Union, also with the motto, 'Montani Semper Liberi' (Mountaineers Are Always Free). Above the coat-of-arms of the State of West Virginia there shall be a ribbon lettered, 'State of West Virginia,' and arranged appropriately around the lower part of the coat-of-arms of the State of West Virginia a wreath of Rhododendron Maximum in proper colors. The field of pure white shall be bordered by a strip of blue on four sides. The flag of the State of West Virginia when used for parade purposes shall be trimmed with gold colored fringe on three sides and when used on ceremonial occasions with the United States ensign, shall be trimmed and mounted in similar fashion to the United States flag as regards to fringe, cord, tassels and mounting."

STATE FLOWER

The Rhododendron Maximum, or “big laurel” is the State flower of West Virginia. It was selected on January 23, 1903, by a joint resolution of both houses of the Legislature, following a vote by pupils of the public schools. It is a shrub of the heath family and may be recognized by its large evergreen leaves and delicate pale pink or white bloom, mottled with either red or yellow flecks.



STATE TREE

The Sugar Maple, *Acer Saccarum* as it is known scientifically, was made West Virginia’s official tree by a concurrent resolution of the 1949 Legislature. It provides an excellent wood for furniture and produces maple syrup. A single tree is 70-120 feet high and produces two to three pounds of sugar when “sugared off”. It has a five lobed leaf and a small wing-shaped seed pod.



STATE BIRD

The Cardinal was made West Virginia’s official bird by concurrent resolution of the 1949 Legislature. The male of the species is a rich scarlet with a mask and shading of black, while the young birds and females are a less brilliant color. The cardinal measures approximately eight inches long and is found from New York State to the Gulf of Mexico and as far west as Oklahoma. Its scientific name is *Cardinalis Cardinalis*.



STATE ANIMAL

The Black Bear or *Euarctos Americanus* is actually deeply tinted with brown. His habitat in West Virginia is primarily in the Eastern Mountain Region. He still roams freely throughout 36 states and Canada. Either one or two cubs, rarely three, are born at a time, weighing about eight ounces each. The adult reaches an average maximum weight of 250 pounds.

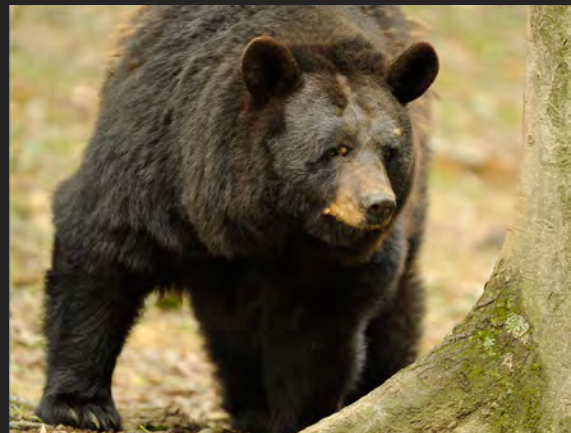

Photos courtesy of the West Virginia Division of Culture and History.

THE GREAT SEAL OF WEST VIRGINIA



Joseph H. Diss Debar, an artist from Doddridge County, was chosen by a committee of the Legislature to prepare drawings for an official seal for the State of West Virginia. The artist submitted his drawings with an explanation of each detail and from these was adopted by the Legislature, a seal which has remained without change, the Official Seal of West Virginia. The seal contains the Latin motto, *Montani Semper Liberi*, which means “Mountaineers Are Always Free”. A large stone in the center of the seal stands for strength. On the stone is the date on which the State was admitted to the Union, June 20, 1863. The farmer with his axe represents agriculture and the miner with his pick represents industry. In front of the rock are two rifles, crossed and surmounted at the place of contact by the Phrygian cap, or cap of liberty, indicating that freedom and liberty were won and will be maintained by the force of arms. While the seal was designed and adopted with two sides, only the front side is in common use. The reverse side of laurel and oak leaves, log house, hills, factories and boat is the Governor’s Official Seal. The Constitution of West Virginia, Article 2, Section 7, provides that: “The present seal of the State, with its motto ‘*Montani Semper Liberi*’ shall be the great seal of the State of West Virginia, and shall be kept by the Secretary of State, to be used by him, officially as directed by law.”

PRESIDENTS OF THE SENATE

Name	County	Years Elected
Phelps, John M. (R)	Mason	1863
Stevenson, William E. (R)	Wood	1864-68
Farnsworth, D. D. T. (R)	Upshur	1869-70
Baker, Lewis (D)	Ohio	1871
*Sperry, Carlos A. (D)	Greenbrier	1872
*Johnson, Daniel O. (D)	Tyler	1872-75
Arnett, Ulysses N. (D)	Marion	1877
Johnson, Daniel D. (D)	Tyler	1879
Summer, Albert E. (D)	Kanawha	1881
Farnsworth, Thomas J. (D)	Upshur	1883
Price, George E. (D)	Mineral	1885-87
Carr, Robert S. (D)	Kanawha	1889
McCreery, John W. (D)	Raleigh	1891
Wiley, Rankin, Jr. (D)	Mason	1893
Worley, William G. (R)	Preston	1895
Whitaker, Nelson E. (R)	Ohio	1897
Marshall, Oliver S. (R)	Hancock	1899
Smith, Anthony (R)	Tyler	1901
May, Clarke W. (R)	Lincoln	1903
Northcott, Gustavus A. (R)	Cabell	1905
McDermott, Joseph H. (R)	Monongalia	1907
Forman, L. J. (R)	Grant	1909
Hatfield Dr. H. O. (R)	McDowell	1911
Woods, Samuel V. (D)	Barbor	1913
England, E.T. (R)	Logan	1915
Goody-Koontz, Wells (R)	Mingo	1917
Sinsel, Dr. Charles A. (R)	Taylor	1919
Arnold, Gohen C. (R)	Upshur	1921
Shaffer, Harry G. (R)	Boone	1923
†Coffman, Charles G. (R)	Harrison	1925
†White, M. Z. (R)	Mingo	1925-27-29-31
Mathews, A. G. (D)	Calhoun	1933
Hodges, Charles E. (D)	Monongalia	1935-37
LaFon, William M. (D)	Monroe	1939
Randolph, Bryon B. (D)	Harrison	1941
Paull, James (D)	Brooke	1943
Vickers, Arnold M. (D)	Fayette	1945-47
Johnston, W. Broughton (D)	Mercer	1949-51
Bean, Ralph J. (D)	Hardy	1953-55-57-59
Carson, Howard W. (D)	Fayette	1961-63-65-67
Jackson, Lloyd G. (D)	Lincoln	1969
McCourt, E. H. (D)	Webster	1971
Brotherton, W. T., Jr. (D)	Kanawha	1973-75-77-79
McGraw, Warren R. (D)	Wyoming	1981-83
Tonkovich, Dan (D)	Marshall	1985-87
▲Tucker, Larry A. (D)	Nicholas	1989
▲Burdette, Keith (D)	Wood	1989-91-93
Tomblin, Earl Ray (D)	Logan	1995-97-01-03-07-09-11
Kessler, Jeffrey (D)	Marshall	2011-14
Cole, William P. (R)	Mercer	2015
Carmichael, Mitch B. (R)	Jackson	2017-2020
Blair, Craig (R)	Berkeley	2021-2024
Smith, Randy (R)	Preston	2025 to Present

*Two Presidents of the Senate were elected in 1872. After the new Constitution was adopted in that year a special session of the newly elected members of the Legislature was held and Daniel D. Johnson was elected President to succeed Carlos A. Sperry.

†Charles G. Coffman was elected President at the beginning of the 1925 session, but was unable to serve on account of illness, and on April 15, 1925, M. Z. White was elected as his successor.

▲Keith Burdette was elected September 12, 1989, to fill the vacancy caused by the resignation of Larry A. Tucker, September 7, 1989.

SPEAKERS OF THE HOUSE

Name	County	Years Elected
Patrick, Spicer (R)	Kanawha	1863
Kramer, Lee Roy (R)	Monongalia	1864-65
Pinnel, David S. (R)	Upshur	1866-67
McWhorter, Henry C. (R)	Kanawha	1868
Fleming, Solomon (R)	Harrison	1869
Welch, William M. (R)	Mineral	1870
Cracraft, Elbridge G. (D)	Ohio	1871
*Summer, Albert E. (D)	Kanawha	1872
*Miller, W. W. (D)	Ohio	1872
Monroe, Alexander (D)	Hampshire	1875
Gibson, Eustace (D)	Cabell	1877
Moffett, George H. (D)	Pocahontas	1879
Wilson, E. Willis (D)	Kanawha	1881
Woods, Joseph J. (D)	Ohio	1883, 89
Dennis, Thomas H. (D)	Greenbrier	1885
Rowan, John M. (D)	Monroe	1887
Bennett, Louis (D)	Lewis	1891
Shaw, David W. (D)	Barbour	1893
Edwards, Wm. Seymour (R)	Kanawha	1895
Hanen, Samuel R. (R)	Marshall	1897
McKinney, Owen S. (D)	Marion	1899
Wilson, William G. (R)	Randolph	1901
Moats, Frank P. (R)	Wood	1903
Grosscup, Fred Paul (R)	Kanawha	1905
Seaman, James A. (R)	Jackson	1907
Strickling, J. H. (R)	Tyler	1909
Wetzel, C. M. (D)	Jefferson	1911
George, William T. (R)	Barbour	1913
Johnson, Vernon E. (R)	Morgan	1915
Thurmond, Joseph S. (D)	Greenbrier	1917
Wolfe, J. Luther (R)	Jackson	1919
Keatley, Edwin M. (R)	Kanawha	1921, 25
Byne, W. E. R. (D)	Kanawha	1923
Johnson, Vernon E. (R)	Morgan	1927
Cummins, J. William (R)	Ohio	1929
Taylor, J. Alfred (D)	Fayette	1931
Hiner, Ralph M. (D)	Pendleton	1933
Pelster, John J. (D)	Logan	1935
Thomas, James Kay (D)	Kanawha	1937-39
Arnold, Malcom R. (D)	Boone	1941
Amos, John E. (D)	Kanawha	1943-45-47
Flannery, W. E. (D)	Logan	1949-51-53-55-57
†Pauley, Harry R.	McDowell	1959
Singleton, Julius W., Jr. (D)	Monongalia	1961-63
White, H. Laban (D)	Harrison	1965-67
Boiarsky, Ivor F. (D)	Kanawha	1969
McManus, Lewis H. (D)	Raleigh	1971-73-75
Kopp, Donald L. (D)	Harrison	1977
See, Clyde M., Jr. (D)	Hardy	1979-81-83
Albright, Joseph P. (D)	Wood	1985
Chambers, Robert C. (D)	Cabell	1987-89-91-93-95
Kiss, Robert S. (D)	Raleigh	1997-01-03-06
▲Thompson, Richard (D)	Wayne	2007-09-11-13
◆Miley, Timothy (D)	Harrison	2013
Armstead, Tim (R)	Kanawha	2015-18
Hanshaw, Roger (R)	Kanawha	2019-Present

*Two Speakers of the House were elected in 1872. After the Constitution was adopted in that year a special session of the newly elected members of the Legislature was held and W. W. Miller was elected Speaker of the House to succeed Albert E. Summers.

†Elected Speaker June 23, 1958, to fill the vacancy caused by the death of W. E. Flannery, and reelected Speaker of the 1959 session.

▲Elected Speaker March 13, 1971, to fill the vacancy caused by the death of Ivor F. Boiarsky, and reelected in the 1973 Session.

◆Elected Speaker June 18, 2013, in an Extraordinary Session of the House of Delegates to replace Richard Thompson who was appointed as Secretary of Veterans Affairs.

CLERKS OF THE SENATE

Name	County	Time of Service
Hall, Ellery R. (R)	Marion	1863 to 1868
Moore, Edward W. S. (R)	Marion	1869 to 1871
Miller, Joseph S. (D)	Cabell	1872 to 1875
Cunningham, E. A. (D)	Pendleton	1877 to 1879
Johnson, D. D. (D)	Tyler	1881
Alderson, John D. (D)	Nicholas	1883 to 1887
Walker, George J. (D)	Jackson	1889
Armstrong, Holly G. (D)	Jackson	1891
Byrne, William E. R. (D)	Braxton	1893
Harris, John T. (R)	Wood	1895 to 1928
Hodges, M. S. (R)	Pendleton	1929 to 1933
Lively, Charles (D)	Lewis	1933 to 1941
Watkins, A. Hale (D)	Marion	1941 to 1943
Watkins, Fred B. (D)	Taylor	1943
Myers, J. Howard (D)	Berkley	1945 to 1972
Carson, Howard W. (D)	Fayette	1972 to 1974
Dillon J. C., Jr. (D)	Summers	1975 to 1979
Willis, Todd C. (D)	Logan	1980 to 1989
Holmes, Darrell E. (D)	Kanawha	1989 to 2013
Minard, Joseph M. (D)	Harrison	2013 to 2015
Barnes, Clark S. (R)	Randolph	2015 to 2017
Lee Cassis (I)	Kanawha	2018 to Present

CLERKS OF THE HOUSE

Name	County	When Elected
Hall, Granville D. (R)	Harrison	1863-64-65
Hubbard, William P. (R)	Ohio	1866-67-68-69-70
Burdett, William T. (D)	Kanawha	1871
Peyton, J. Bernard (D)	Kanawha	1872 to 1898
Hamilton, John M. (D)	Calhoun	1899
Dawson, Wm. M. O. (R)	Preston	1895
Hood, E. E. (R)	Kanawha	1897
Byrne, William E. R. (D)	Kanawha	1899
Shaw, Harry (R)	Marion	1901-03-05
Topping, C. L. (R)	Kanawha	1907-09-19
Neely, M. M. (D)	Marion	1911
Pritchard, John Guy (R)	Marion	1913-15
Hamilton, Robt. L. (D)	Calhoun	1917-23
Hodges, M. S. (R)	Pendleton	1921-25-27
Reed, L. V. (R)	Tyler	1929
Kidd, R. H. (D)	Taylor	1931
Hall, John S. (D)	Mingo	1933-41
Aliff, J. R. (D)	Fayette	1941-53
*Blankenship, C. A. (D)	Wyoming	1955 to 1982
Kopp, Donald L. (D)	Harrison	1983 to 1995
†Gray, Gregory, M. (D)	Kanawha	1996 to 2015
**Hoover, Bo	Kanawha	2015
Harrison, Stephen J. (R)	Kanawha	2015-2024
Jeff Pack (R)	Raleigh	2025 to Present

*Appointed by Governor Marland, April 15, 1954, to fill unexpired term of J.R. Aliff, who resigned; elected Clerk January 12, 1955.

†Appointed by House Speaker Chambers, January 1, 1996, to fill unexpired term of Donald L. Kopp, who resigned elected Clerk January 10, 1996.

**Appointed by House Speaker Miley, January 8, 2015, to fill unexpired term of Gregory Gray, who resigned December 31, 2014.

COUNTY HISTORY

BARBOUR

Formed in 1843 from parts of Randolph, Harrison and Lewis counties; named in honor of Phillip Pendleton Barbour, distinguished jurist of Virginia. **County Seat:** *Phillipi*. **Area:** 345.41 mi². **Population:** 15,465.

BERKELEY

Second oldest county in West Virginia. Created in 1772 from the northern third of Frederick County (Virginia), and named for Norborne Berkeley (Baron de Botetourt), colonial governor of Virginia from 1768 to 1770. **County Seat:** *Martinsburg*. **Area:** 324.78 mi². **Population:** 122,076.

BOONE

Formed in 1847 from parts of Kanawha, Cabell and Logan counties and named for Daniel Boone, noted hunter and explorer whose home was in the great Kanawha Valley from 1789 to 1795. **County Seat:** *Madison*. **Area:** 506 mi². **Population:** 21,809.

BRAXTON

Formed in 1836 from parts of Lewis, Kanawha and Nicholas counties and named for Carter Braxton, Virginia statesman and signer of the Declaration of Independence. **County Seat:** *Sutton*. **Area:** 519.7 mi². **Population:** 12,447.

BROOKE

Created in 1797 from part of Ohio County and named in honor of Robert Brooke, governor of Virginia from 1794 to 1796. **County Seat:** *Wellsburg*. **Area:** 95.5 mi². **Population:** 22,559.

CABELL

Created in 1809 from Kanawha County and named in honor of William H. Cabell, governor of Virginia from 1805 to 1808. County seat moved from Barboursville to Huntington in 1887. **County Seat:** *Huntington*. **Area:** 285.95 mi². **Population:** 94,350.

CALHOUN

Created in 1856 from Gilmer County and named for John C. Calhoun, eminent statesman of South Carolina. In early years the county seat was located in Arnoldsburg, Brooksville and at the mouth of Pine Creek. **County Seat:** *Grantsville*. **Area:** 280.2 mi². **Population:** 7,627.

CLAY

Formed in 1858 from parts of Braxton, Kanawha and Nicholas counties and named in honor of Henry Clay, Kentucky statesman. **County Seat:** *Clay*. **Area:** 346.61 mi². **Population:** 8,051.

DODDRIDGE

Created in 1845 from parts of Harrison, Tyler, Ritchie and Lewis counties and named for Phillip Doddridge, a distinguished statesman of western Virginia, who spent the greater part of his life in Brooke County, West Virginia. Home county of J. H. Diss DeBar, who designed the Great Seal and Coat-of-Arms of West Virginia. **County Seat:** *West Union*. **Area:** 321.61 mi². **Population:** 7,808.

FAYETTE

Created in 1831 from parts of Greenbrier, Kanawha, Nicholas and Logan counties, and named in honor of the Marquis de LaFayette. First court held at New Haven, near Ansted. **County Seat:** *Fayetteville*. **Area:** 668.5 mi². **Population:** 40,488.

GILMER

Formed in 1845 from parts of Lewis and Kanawha counties and named for Thomas Walker Gilmer, governor of Virginia 1840 – 1841, later a representative in Congress, and secretary of the Navy in President Tyler's cabinet. **County Seat:** *Glenville*. **Area:** 342.40 mi². **Population:** 7,408.

GRANT

Created from Hardy County in 1866 and named for General Ulysses Simpson Grant. **County Seat:** *Petersburg*. **Area:** 478 mi². **Population:** 10,976.

GREENBRIER

Second largest county in West Virginia. Created in 1778 from parts of Montgomery and Botetourt counties (Virginia) and named for the principal river which drains the county. The first permanent settlement was established in 1769 at Frankford (unincorporated). **County Seat:** *Lewisburg*. **Area:** 1,022.8 mi². **Population:** 32,977.

HAMPSHIRE

Oldest County in West Virginia. Formed from parts of Frederick and Augusta counties (Virginia) in 1754 and named for the English Shire of the same name. **County Seat:** *Romney*. **Area:** 641.41 mi². **Population:** 23,093.

HANCOCK

Smallest county in the state. Created from Brooke County in 1848 and named for John Hancock, first signer of the Declaration of Independence. **County Seat:** *New Cumberland*. **Area:** 88.55 mi². **Population:** 29,095.

HARDY

Created from Hampshire County in 1786 and named for Samuel Hardy, a distinguished Virginian. **County Seat:** *Moorefield*. **Area:** 575.52 mi². **Population:** 14,299.

HARRISON

Created in 1784 from Monongalia County and named for Benjamin Harrison, distinguished Virginian, who was the father of William Henry Harrison, ninth president of the United States, and the great grandfather of Benjamin Harrison, twenty-third president. **County Seat:** *Clarksburg*. **Area:** 417.85 mi². **Population:** 65,921.

JACKSON

Formed in 1831 from parts of Kanawha, Wood and Mason counties and named for Andrew Jackson, seventh president of the United States. **County Seat:** *Ripley*. **Area:** 471.98 mi². **Population:** 27,791.

JEFFERSON

Formed from Berkeley County in 1801 and named for Thomas Jefferson, author of the Declaration of Independence, and third president of the United States. **County Seat:** *Charles Town*. **Area:** 212.41 mi². **Population:** 57,701.

KANAWHA

Formed from parts of Greenbrier and Montgomery counties (Virginia) in 1788. Named for Great Kanawha River, which received its name from the Indian tribe that once dwelt in the territory now embraced within the county. **County Seat:** *Charleston*. **Area:** 913.38 mi². **Population:** 180,745.

LEWIS

Created in 1816 from Harrison County and named for Colonel Charles Lewis, famous soldier and leader among the Virginia Pioneers, who was killed at the Battle of Point Pleasant in 1774. **County Seat:** *Weston*. **Area:** 391.35 mi². **Population:** 17,033.

LINCOLN

Formed in 1867 from parts of Cabell, Putnam, Kanawha and Boone counties and named in honor of Abraham Lincoln, the sixteenth president of the United States. **County Seat:** *Hamlin*. **Area:** 437 mi². **Population:** 20,463.

MARION

Created in 1842 from parts of Monongalia and Harrison counties and named in honor of General Francis Marion of Revolutionary War fame, known in history as “The Swamp Fox”. **County Seat:** *Fairmont*. **Area:** 313.55 mi². **Population:** 56,205.

MARSHALL

Formed from Ohio County in 1835 and named for John Marshall, for thirty-four years chief justice of the United States Supreme Court. Elizabethtown, named as the county seat in the act creating the county, was combined with Moundsville in 1866. **County Seat:** *Moundsville*. **Area:** 315.26 mi². **Population:** 30,591.

MASON

Formed in 1804 from the western portion of Kanawha County and named for George Mason, author of the Constitution of Virginia and a member of the convention that framed the Constitution of the United States. **County Seat:** *Point Pleasant*. **Area:** 445.74 mi². **Population:** 25,453.

MCDOWELL

Created in 1858 from Tazewell County (Virginia) and named in honor of James McDowell, governor of Virginia. **County Seat:** *Welch*. **Area:** 538.4 mi². **Population:** 19,111.

MERCER

Established in 1837 from parts of Giles and Tazewell counties (Virginia) and named in honor of General Hugh Mercer of Revolutionary War fame. **County Seat:** *Princeton*. **Area:** 423.91 mi². **Population:** 59,664.

MINERAL

Created in 1866 from Hampshire County and so named because of the mineral resources found there. Important frontier forts were located in the county during Indian wars. **County Seat:** *Keyser*. **Area:** 330 mi². **Population:** 26,938.

MINGO

Youngest county in the state, formed from Logan County in 1895 and named for the Indian tribe of which Logan was chief. **County Seat:** *Williamson*. **Area:** 423.5 mi². **Population:** 23,568.

MONONGALIA

Formed in 1776 from the District of West Augusta (Virginia) and named for the Monongahela River. **County Seat:** *Morgantown*. **Area:** 386.82 mi². **Population:** 105,822.

MONROE

Created from Greenbrier County in 1799 and named for James Monroe, fifth president of the United States. **County Seat:** *Union*. **Area:** 473.8 mi². **Population:** 12,376.

MORGAN

Formed in 1820 from parts of Hampshire and Berkeley counties and named in honor of General Daniel Morgan, prominent soldier of the Revolution. **County Seat:** *Berkeley Springs*. **Area:** 231.26 mi². **Population:** 17,063.

NICHOLAS

Formed in 1818 from parts of Kanawha, Greenbrier and Randolph counties and named for Wilson Cary Nicholas, governor of Virginia, 1814-16. Carnifex Ferry Battlefield Park and part of Monongahela National Forest are located in this county. **County Seat:** *Summersville*. **Area:** 656.77 mi². **Population:** 24,604.

OHIO

Formed in 1776 from the District of West Augusta (Virginia) and named for the county's principal river, the Ohio, Indian name of "Great River." One of the first counties in Virginia organized west of the Allegheny Mountains. **County Seat:** *Wheeling*. **Area:** 109 mi². **Population:** 42,425.

PENDLETON

Created in 1788 from parts of Augusta, Hardy and Rockingham counties (Virginia) and named for Edmund Pendleton, a distinguished statesman and jurist of Virginia. **County Seat:** *Franklin*. **Area:** 696.88 mi². **Population:** 6,143.

PLEASANTS

Created in 1851 from Wood, Tyler and Ritchie counties, and named for James Pleasants, Jr., who represented Virginia in the United States Senate, and who was its governor, 1822 – 25. **County Seat:** *St. Mary's*. **Area:** 134.65 mi². **Population:** 7,653.

POCAHONTAS

Established in 1821 from parts of Bath, Pendleton and Randolph counties (Virginia) and named for Pocahontas, the Native American princess. **County Seat:** *Marlinton*. **Area:** 942.61 mi². **Population:** 7,869.

PRESTON

Formed in 1818 from Monongalia County and named in honor of James Patton Preston, governor of Virginia, 1816 – 1819. **County Seat:** *Kingwood*. **Area:** 653.88 mi². **Population:** 34,216.

PUTNAM

Created in 1848 from parts of Kanawha, Mason and Cabell counties and named in honor of General Israel Putnam, New England soldier and patriot. **County Seat:** *Winfield*. **Area:** 350.57 mi². **Population:** 57,440.

RALEIGH

Created in 1850 from the southern portion of Fayette County, and named for Sir Walter Raleigh, the English adventurer and soldier. **County Seat:** *Beckley*. **Area:** *610.15 mi²*. **Population:** *74,591*.

RANDOLPH

Formed from the county of Harrison in 1787 and included all of the present county of Tucker, all of Barbour County east of the river, all of Upshur County east of Buckhannon River, and a considerable portion of Pocahontas and Webster counties. It lost territory in 1821 when Pocahontas was formed; again in 1843 when Barbour came into existence; in 1851 it gave up some of its territory to Upshur; five years later 350 square miles were cut off from Tucker; and another portion was incorporated in Webster County when it was formed in 1860. After all of these losses Randolph still is the largest county in the state. It was named for Edmund Jennings Randolph, governor of Virginia 1786–88. The first white man who settled in what is now West Virginia built his home on the waters of the Monongahela. In this county occurred the first Indian massacre in the state. From that beginning, the county has been a historical center down to the present. **County Seat:** *Elkins*. **Area:** *1,046.34 mi²*. **Population:** *27,932*.

RITCHIE

Formed in 1843 from parts of Wood, Harrison and Lewis counties and named in honor of Thomas Ritchie, a distinguished journalist of Richmond, Virginia, whose mother was a sister of Judge Spencer Roane, for whom Roane County was named. **County Seat:** *Harrisville*. **Area:** *455.27 mi²*. **Population:** *8,444*.

ROANE

Created in 1856 from parts of Kanawha, Jackson and Gilmer counties and named in honor of Judge Spencer Roane, a distinguished judge of the Supreme Court of Appeals of Virginia, whose wife Anne, was the daughter of Patrick Henry. **County Seat:** *Spencer*. **Area:** *486.20 mi²*. **Population:** *14,028*.

SUMMERS

Formed in 1871 from parts of Monroe, Mercer, Greenbrier and Fayette counties and named in honor of George W. Summers, a prominent jurist of Kanawha County. **County Seat:** *Hinton*. **Area:** *367.76 mi²*. **Population:** *11,959*.

TAYLOR

Created in 1844 from parts of Harrison, Barbour and Marion counties and named for Senator John Taylor (1750 – 1824), distinguished soldier and statesman of Carolina County, Virginia. **County Seat:** *Grafton*. **Area:** *177.19 mi²*. **Population:** *16,705*.

TUCKER

Formed in 1856 from Randolph County and named for Henry St. George Tucker (1780 – 1848), an eminent jurist and statesman of Virginia. **County Seat:** *Parsons*. **Area:** *421.67 mi²*. **Population:** *6,762*.

TYLER

Created from Ohio County in 1814 and named in honor of John Tyler, eighth governor of Virginia and father of John Tyler, tenth president of the United States. **County Seat:** *Middlebourne*. **Area:** *260.12 mi²*. **Population:** *8,313*.

UPSHUR

Formed in 1851 from Randolph, Barbour and Lewis counties and named for Abel Parker Upshur, distinguished statesman and jurist of Virginia. **County Seat:** *Buckhannon*. **Area:** 354.86 mi². **Population:** 23,816.

WAYNE

Formed from Cabell County in 1842 and named in honor of General Anthony Wayne of Revolutionary War fame. **County Seat:** *Wayne*. **Area:** 517.88 mi². **Population:** 38,982.

WEBSTER

The last county in West Virginia to be created before the separation from Virginia. Created in 1860 from Nicholas, Braxton and Randolph counties and named in honor of Daniel Webster, New England orator and statesman. **County Seat:** *Webster Springs*. **Area:** 558.6 mi². **Population:** 8,378.

WETZEL

Created in 1846 from Tyler County and named for Lewis Wetzel, famous frontier character and Indian fighter. **County Seat:** *New Martinsville*. **Area:** 360.47 mi². **Population:** 14,442.

WIRT

Formed in 1848 from Wood and Jackson counties and named for William Wirt of Maryland, who gained fame as an author, orator and lawyer in his adopted State of Virginia. **County Seat:** *Elizabeth*. **Area:** 234.41 mi². **Population:** 5,194.

WOOD

Formed in 1798 from Harrison County and named in honor of James Wood, governor of Virginia (1796–99). **County Seat:** *Parkersburg*. **Area:** 87,986 mi². **Population:** 84,296.

WYOMING

Created in 1850 from Logan County and named for the Delaware Indian word meaning “large plains”. **County Seat:** *Pineville*. **Area:** 507.3 mi². **Population:** 21,382.

WEST VIRGINIA GOVERNMENT

CONSTITUTION

(Preamble) “Since through Divine Providence we enjoy the blessings of civil, political and religious liberty, we, the people of West Virginia, in and through the provisions of this Constitution, reaffirm our faith in and constant reliance upon God and seek diligently to promote, preserve and perpetuate good government in the State of West Virginia for the common welfare, freedom and security of ourselves and our posterity.” (This preamble was proposed by House Joint Resolution No. 8, Acts 1959, Page 659; submitted by Acts 1960, c-4; and ratified November 8, 1960.)

West Virginia adopted its first constitution in 1863, when it became the 35th state in the Union. The state is now governed by its second constitution, adopted in 1872. The constitution may also be revised by a constitutional convention. Before a constitutional convention can be called, it must be approved by a majority of the legislators and the voters.

EXECUTIVE

The Governor of West Virginia is the state’s chief executive and is elected to a four-year term. They may serve any number of terms, but not more than two terms in succession. In case of the death, conviction or impeachment, failure to qualify, resignation, or other disability of the Governor, the President of the Senate shall act as Governor until the vacancy is filled, or the disability removed; and if the President of the Senate, for any of the above-named causes, shall become incapable of performing the duties of Governor, the same shall revolve upon the speaker of the House of Delegates; and in all other cases where there is no one to act as Governor, one shall be chosen by joint vote of the Legislature. Whenever a vacancy shall occur in the office of the Governor before the first three years of the term shall have expired, a new election for Governor shall take place to fill the vacancy.

The heads of many state administrative departments are appointed by the Governor with the advice and consent of the Senate. Other top state officials include the Secretary of State, Auditor, Treasurer, Attorney General, and the Commissioner of Agriculture. They are elected to a four-year term and can succeed themselves as many times as they are elected.

LEGISLATURE

The West Virginia Legislature is a bicameral legislature which means it is composed of two chambers, The Senate and House of Delegates. The voters of each of the state’s 17 senatorial districts elect two Senators to four-year terms. Each of the state’s 100 delegate districts elects 1 to 5 delegates.

The Legislature meets every year. Regular sessions begin on the second Wednesday of January except in the year after an election for governor. In that year, the regular session starts on the second Wednesday of February. Sixty calendar days is the regular session; however, it may be extended by a concurrent resolution adopted by a two-thirds vote of the members elected to each house. The Governor may call extraordinary sessions.

COURTS

There are three levels of courts - the Supreme Court of Appeals, the Intermediate Court of Appeals, the Circuit Court and the Magistrate or “peoples’ court”. The highest court in West Virginia is the Supreme Court of Appeals, which has five justices, who are elected to twelve year terms. Beginning with the January 1980 term and continuing thereafter, on the first day of the January term of each year, a Chief Justice is selected from the members of the court in accordance with the justices’ seniority.

- Supreme Court elected to 12-year terms, 5 justices who select a Chief Justice annually.
- Intermediate Court created during the 2021 Regular Session by SB275, with three judges elected to ten-year terms.
- Circuit Court has 31 judicial circuits, and 75 circuit judges elected to eight-year terms.
- Family Court initial term is 6 years and every subsequent term is an eight-year term. There are 27 family court circuits with 47 family judges.
- Magistrate Courts in West Virginia contain 158 magistrates elected to four-year terms. Magistrate courts are trial courts of limited jurisdictions.
- Municipal Courts are locally administered, mostly hearing cases of municipal ordinance violations, and are elected to four-year terms. Established by WV Code §8-10-2.
- There are 31 judicial circuits and each has at least one circuit judge. Circuit judges are elected for a term of eight years.
- Magistrates are elected to a four-year term and their salaries, which are set by the Legislature, depend upon the population of the county in which they serve. Each county has at least two magistrates.

COUNTY GOVERNMENT

Counties are governed by county commissions which have executive, legislative and some quasi-judicial functions. County commissioners, county clerks, and circuit clerks are elected for six-year terms. Other county officials include a prosecuting attorney, who is the county’s chief law-enforcement officer; an assessor; a sheriff; and a surveyor, who are elected for four year terms.



1863-1870 Linsly Institute, Wheeling, WV



1885-1921 Capitol, Charleston

CAPITOL HISTORY

Photos courtesy of the West Virginia and Regional History Center, West Virginia University Libraries. Photo, far right: Perry Bennett. Capitol Information Courtesy of the West Virginia Division of Culture and History.

The history of the State Capitol began in Wheeling, where the Linsly Institute Building, constructed in 1858, served as the state's first Capitol building from June 20, 1863 to April 1, 1870.

The Legislature later voted to move the Capitol south to Charleston. A shift in economic and political power from Republican to Democrat and from northern to southern directly influenced the decision to move the seat of government to Charleston. A packed boat floated the state's officials and documents down the Ohio River and east on the Kanawha River to the new Capitol. State officials took up residence in churches, schools and other available buildings while a new, three-story

building was being constructed at Capitol and Lee streets in downtown Charleston.

In 1875, a group of Wheeling businessmen enticed the Legislature with a free public building to return the capitol to Wheeling. The government moved by boat back to Wheeling. Officials settled into the Linsly Institute building, and then into a stone structure donated by Wheeling.

Still not satisfied with the choice of Wheeling, the 1877 Legislature decided to ask the citizens of West Virginia to vote on the permanent location of their Capitol. West Virginians were offered the cities of Charleston, Clarksburg, or

Martinsburg. They chose Charleston. When the new Capitol was completed in 1885, state officials and records were again transported from Wheeling on the Ohio and Kanawha Rivers, this time on two steamers and a barge. West Virginia's seat of government became known as the "Floating Capitol."

The new building served as the State Capitol for 36 years until, on January 3, 1921, it was destroyed by fire. Thousands of rounds of ammunition confiscated in recent conflicts in the coalfields added fuel to the blaze. A temporary structure of wood and wallboard was hastily erected in 42 days. For the next six years, West Virginia's state government was run from the "Pasteboard Capitol."



1885-1921 Capitol, Charleston



1870-1875 Capitol, Charleston



Capitol, Charleston (Present day)

The make-shift Capitol went up in flames on March 2, 1927. After the 1921 fire, the Legislature had created the Capitol Building Commission which authorized construction on the present Capitol on the North bank of the Kanawha River in East Charleston.

The present Capitol took eight years to complete at a cost of just under \$10 million. It was constructed in three stages. The west wing was built in 1924 - 1925; the east wing was constructed in 1926 - 1927; and the rotunda connecting the wings was completed in 1930 - 1932. Governor William G. Conley dedicated the new Capitol on the state's 69th birthday, June 20, 1932.

Cass Gilbert, born in Zanesville, Ohio, in 1859, studied architecture at the Massachusetts Institute of Technology. In 1912, Gilbert designed the world's first skyscraper, the Woolworth Building in New York City. His other works include the state capitols of Minnesota and Arkansas, the U.S. Treasury Building and the U. S. Supreme Court Building in Washington, D. C. Gilbert died in 1934, just two years after West Virginia's State Capitol was completed.

The huge bell resting on the Capitol lawn is a grim reminder of the disastrous fire of 1921 that destroyed the statehouse built in 1885. The bell for years tolled the time for hundreds of townspeople and there

was more than a passing touch of sorrow in its fall to the ground, causing a crack extending almost around its surface.

The figure "3" of the clock tower that housed the bell was salvaged from the ruins and presented to the Department of Archives and is now in display in the museum.

Weighing several tons, the bell was cast by the Clinton H. Meneely Company of Troy, N. Y. in 1887. The State Board of Public Works accepted the bell July 7, 1888.

GOVERNORS OF WEST VIRGINIA

ARTHUR INGRAM BOREMAN

The first governor of West Virginia. At the outbreak of the Civil War, he presided over the Wheeling Convention, which formed a reorganized government of Virginia in an effort to remain loyal to the Union. He resigned near the end of his term to serve in the U. S. Senate. (1863-69)

DANIEL DUANE TOMPKINS FARNSWORTH

A strong supporter of statehood, served six days between the resignation of Boreman (who became a U. S. Senator) and the Inauguration of newly-elected Governor Stevenson. (February 26, 1869 - March 4, 1869)

WILLIAM ERSKINE STEVENSON

Encouraged the repeal of loyalty Test Oath laws for former Confederates and restored their right to vote. (1869-71)

JOHN JEREMIAH JACOB

Attempted to settle differences between Union advocates and Confederate sympathizers. During his first term in office, our state constitution was written and adopted. (1871-77)

HENRY MASON MATHEWS

Elected to the State Senate but, because he had served in the Confederate Army, he refused to take the loyalty Test Oath and failed to qualify for his seat. He was elected governor after the loyalty Test Oath laws were repealed. Mathews reportedly called for federal and state troops to put down mine and rail strikes in the state. (1877-81)

JACOB BEESON JACKSON

A partisan Democrat who was an advocate of tax reform. He increased property values to provide funds for state institutions. (1881-85)

EMANUEL WILLIS WILSON

Served almost a year beyond his term due to a disputed election. He opposed unfair railroad practices and general monopolies. (1885-90)

ARETAS BROOKS FLEMING

One of for men who claimed the governor's seat in a disputed election. The Australian ballot law providing for uniform printed ballots was enacted during his term. (1890-93)

WILLIAM ALEXANDER MACCORKLE

Elected governor at the age of 35, tirelessly promoted West Virginia. His term was troubled by a series of labor problems with the railroads and the mines. (1893-97)

GEORGE WESLEY ATKINSON

Asked the Legislature for the eight-hour work day, a child labor law, and proper working conditions for women. (1897-1901)

ALBERT BLAKESLEE WHITE

Obsessed with the state's faulty tax structure, and he pushed for reforms. (1901-05)

WILLIAM MERCER OWENS DAWSON

Proposed a tax program to increase state revenues. Dawson recommended building a new Capitol condemning the old one as a firetrap. (1905-09)

WILLIAM ELLSWORTH GLASSCOCK

Declared martial law when the mine wars began in 1912. Labor unrest continued throughout his term. (1909-13)

HENRY HATFIELD

Pushed for one of the first workmen's compensation laws in the nation. He personally dealt with mine owners and laborers in an attempt to resolve the mine wars. (1913-17)

JOHN JACOB CORNWELL

Created a state police force in response to violence at the mines. Voters approved \$50 million to pave dirt roads. (1917-21)

EPHRAIM FRANKLIN MORGAN

Pushed for highway safety laws and established a road commission. During his term, the mine wars came to an end in 1923. (1921-25)

HOWARD MASON GORE

Raised funds for road construction with an increase in the gasoline tax. Voters approved another \$35 million for highways. (1925-29)

WILLIAM GUSTAVUS CONLEY

Held office during the depression. Much of the legislation enacted under his administration was concerned with poor economic conditions. (1929-33)

HERMAN GUY KUMP

Put the state and its citizens back on a firm financial footing by adopting the state's first consumer sales tax, a personal income tax and by creating the Department of Public Assistance. (1933-37)

HOMER ADAMS HOLT

Was anti-labor and quickly asserted his authority when unions threatened strikes. Economic conditions improved during his term in office. (1937-41)

MATTHEW MANSFIELD NEELY

An uncompromising Democrat, he was a friend of labor. His administration increased mine inspections, created a Human Relations Commission, and increased welfare grants. (1941-45)

CLARENCE WATSON MEADOWS

Reorganized many state agencies to make them less political and more efficient. He took personal action in resolving strikes and fought for a raise for the state's teachers. (1945-49)

OKEY LEONIDAS PATTERSON

Located the state medical school at Morgantown. He pledged cash bonuses for the veterans of WWI and WWII and passed new taxes on beer, wine and cigarettes to fulfill those pledges. (1949-53)

WILLIAM CASEY MARLAND

Introduced a tax on natural resource industries to fund roads and school programs, but the tax was defeated in the Legislature. He supported school integration. (1953-57)

CECIL HARLAND UNDERWOOD

The Youngest governor to be elected, enacted temporary employment program as mechanization in the coal mines threw thousands into poverty. He battled a Democratic Legislature as the first Republican governor in 24 years. (1957-61)

WILLIAM WALLACE BARRON

Experienced an unemployment decline from more than 100,000 to fewer than 45,000 and the state park system was expanded. (1961-65)

HULLETT CARLSON SMITH

Worked for legislation to control strip mine operations and pollution. State employees were placed under civil service coverage, and the restoration of the Governor's Mansion was completed. (1965-69)

ARCH ALFRED MOORE, JR.

Served two terms marked by advances in road construction, welfare, education and mental health. In 1985, he was elected to an unprecedented third term. (1969-77), (1985-89)

JOHN D. ROCKEFELLER IV

Attracted foreign investors to the state and eliminated an existing sales tax on food. (1977-85)

GASTON CAPERTON III

Sparked a revolution in West Virginia's education system with a nationally recognized education technology program and school building initiative. He also spurred unprecedented job growth and launched an aggressive highway and bridge construction program. (1989-97)

CECIL HARLAND UNDERWOOD

Elected to a second term – youngest and most senior governor to be elected. (1997-2001)

ROBERT E. WISE, JR.

Elected governor November 7, 2000, and sworn into office January 15, 2001. Before becoming the state's chief executive, he served West Virginia's 2nd Congressional District for 18 years. (2001-05)

JOE MANCHIN III

Elected governor November 2, 2004 and sworn into office January 7, 2005. On November 2, 2009, he was elected to fill the late Senator Robert C. Byrd's seat in the U.S. Senate. (2005-10)

EARL RAY TOMBLIN

Became acting governor on November 15 2010, following Joe Manchin's election to the U.S. Senate. On October 4, 2011, he was elected as governor of West Virginia in a special election to fill the unexpired term ending in January 2013. He was reelected on November 6, 2012. (2010-17)

JIM JUSTICE

Elected November 8, 2016 and was sworn into office on January 16, 2017. (2017-2024)

PATRICK MORRISEY

Elected November 5, 2024 and was sworn into office on January 13, 2025. (2025 to Present)

WV HISTORY TIMELINE

- 1671** | The first known white explorers to reach what is now West Virginia were Thomas Batts and Robert Fallam in September, 1671. Their expedition may have ended at the Falls of the Kanawha River and helped establish British claims to the Kanawha and Ohio valleys.
- 1726** | Morgan Morgan was the first permanent settler on record in what is now West Virginia. He settled at Bunker Hill in Berkeley County in 1726-27.
- 1742** | Racine is the site of a memorial marker commemorating the discovery of coal there in 1742, by John Peter Salley. This was the first coal to be reported in West Virginia.
- 1746** | The Fairfax Stone erected October 23, 1746, at the corner of Tucker and Grant counties, marks the western boundary of land granted to Lord Fairfax by the King of England. This was the first monument erected to mark ownership in the state.
- 1766** | The first fair in the state of West Virginia was held in Mecklenberg, now Shepherdstown in 1766.
- 1774** | The battle which is sometimes called the first of the American Revolution was fought at Point Pleasant on October 10, 1774, when General Andrew Lewis and his forces defeated the Indians under Chief Cornstalk, thus opening the Northwest for settlement.
- 1782** | The last battle of the Revolutionary War was fought at Fort Henry, in what is now downtown Wheeling on September 10, 1782.
- 1785** | The first pottery plant was at Morgantown in 1785.
- 1786** | Rehoboth Church near Union, erected July 30, 1786, is the oldest Methodist Church west of the Alleghenies.
- 1787** | The first steamboat was launched by James Rumsey in the Potomac at Mecklenburg, now known as Shepherdstown, on December 3, 1787.
- 1790** | The first newspaper published in West Virginia was the Potomac-Guardian and Berkeley Advertiser, established at Shepherdstown in November 1790.
- 1794** | The first iron furnace built west of the Allegheny Mountains was erected by Peter Tarr on Kings Creek in Hancock County in 1794. Cannonballs were cast here for use by the American Fleet on Lake Erie during the War of 1812.
- 1796** | Lewisburg is the site of the Old Stone Church erected by Scotch-Irish settlers in 1796. It is the oldest church building in continuous use west of the Alleghenies and was used during the Civil War as an emergency hospital.
- 1797** | "The Christian Panoply" the first book published in West Virginia, appeared in 1797 and was written by Richard Watson.
- 1798** | Daniel Boone made his last survey of Charleston on September 8, 1798, and left the state in 1799.

- 1806** | On December 11, 1806, Thomas Jefferson, then president of the United States sent the militia to Blennerhassett Island, near Parkersburg, “to end the plans of Aaron Burr and Harman Blennerhassett to lead a group of settlers and to establish a colony on the Baron Bastrop lands in the Southwest.”
- 1813** | The first glass plant in West Virginia was at Wellsburg.
- 1817** | The first bank established in western Virginia, “The Northwestern Bank of Virginia,” opened in Wheeling on February 5.
- 1817** | The first “trust” in the United States was formed in the Kanawha Valley, where several salt producers concluded a marketing and pricing agreement on November 10.
- 1819** | Cut nails were manufactured in West Virginia as early as 1819 when Robert Aston opened at Wheeling. The first nails from Bessemer Process Steel were made in 1883.
- 1824** | On February 14, 1824, at Harpers Ferry, John S. Gallagher began publication of the “Ladies’ Garland,” one of the first papers in the nation devoted mainly to the interest of women.
- 1838** | The continent’s largest cone-shaped, pre-historic, man-made burial mound, the Grave Creek Mound, is located at Moundsville. It is 70 feet high and 900 feet in circumference at the base. It was first excavated for study on March 19, 1838.
- 1841** | In 1841 William Tomplins used natural gas to evaporate salt brine, thus becoming the first man in the United States to use natural gas for industrial purposes.
- 1845** | The first novel published in the state was “Young Kate” in 1845 by John Lewis.
- 1847** | The first telegraph lines reached West Virginia at Wheeling.
- 1853** | The first through train from the Atlantic Ocean to the Ohio River reached Wheeling on January 1, 1853, on the Baltimore and Ohio Railroad.
- 1854** | The first suspension bridge in the world was completed in Wheeling in November of 1849, but was destroyed in a windstorm in 1854. The present bridge, built in 1856, is the oldest suspension bridge in the world, and the oldest bridge in the Western Hemisphere.
- 1859** | John Brown’s raid at Harpers Ferry occurred on October 16, 1859. Brown was subsequently tried and hanged at Charles Town for treason.
- 1860** | In May 1860, the first well was drilled for producing crude oil in the state at Burning Springs.
- 1861** | The first Wheeling Convention, held May 12, 1861, met to oppose Virginia’s secession from the Union.
- 1861** | Bailey Brown, the first Union soldier killed in the Civil War, died on May 22, 1861, at Fetterman in Taylor County.
- 1861** | The first land battle of the Civil War was fought at Philippi on June 3, 1861.

- 1861** | The second Wheeling Convention, held June 11, 1861, formed the reorganized government of Virginia, adopted the Declaration of Rights, and elected new government officials.
- 1862** | President Abraham Lincoln signed the bill making West Virginia a State on December 31, 1862.
- 1863** | On May 20, 1863, Arthur I. Boreman became the first Governor of West Virginia.
- 1863** | On June 20, 1863, West Virginia was admitted as the 35th state of the Union, the youngest state east of the Mississippi, and the only state ever to be created indirectly by presidential proclamation. West Virginia was created by an act of Congress, like any other new state. The bill specifies that the state renounce slavery as a condition for admission to the Union. When the constitutional convention met again and complied, Lincoln issued his proclamation to recognize that fact and make statehood official.
- 1863** | A naval battle was fought in West Virginia waters during the Civil War. United States Navy armored steamers were actively engaged in the Battle of Buffington Island on the Ohio River near Ravenswood on July 19, 1863. (Only naval battle ever fought on the Ohio River)
- 1863** | On September 26, 1863, the West Virginia Legislature adopted the Great Seal of West Virginia, which is also the Coat-of-Arms.
- 1865** | On April 9, 1865, the first public free school in the state opened at Charleston.
- 1868** | Julia Robertson Pierpont of Fairmont, wife of Francis H. Pierpont, Loyal Virginia's Civil War Governor, originated the movement that May 30, 1868, officially became Decoration Day, which is now celebrated as Memorial Day.
- 1872** | The world's first brick pavement was laid in Charleston during the administration of Dr. John P. Hale, by Mordecai Levi, who at that time was mayor of the city. In 1873, brick pavement was extended to other streets.
- 1879** | The first telephone installed in West Virginia was in Wheeling. A central office serving 52 phones was opened on May 15, 1880.
- 1881** | General Nathan Goff, the first West Virginian to hold a cabinet office, was appointed secretary of the Navy, January 6, 1881. Thomas Ewing, born at West Liberty in 1789, served in the cabinets of William Henry Harrison (1841), John Tyler (1841-45), Zachary Taylor (1849), and Millard Fillmore (1850-53), but was reared in Ohio and living in that state at the time of his appointment.
- 1885** | The seat of government was moved permanently to Charleston from Wheeling on May 1, 1885.
- 1885** | "The West Virginia Hills," an official state song of West Virginia, was written by Ella A. King and published on September 15, 1885.
- 1888** | The first electric railroad in the world, built as a commercial enterprise, was constructed between Huntington and Guyandotte, and began operation June 13, 1888.

- 1891** | The first football game in West Virginia was played in 1891 between West Virginia and Washington and Jefferson College of Pennsylvania. West Virginia was beaten by a score of 72 to 0. This game is interesting because the visiting team had to travel by stage to Brownsville, Pennsylvania, and then by steamboat to Morgantown. No admission was charged for the game, but the hat was passed around for freewill offerings. The fans had to watch the game from large piles of wood on each end of the field.
- 1896** | The first rural free mail delivery was started in Charles Town on October 6, 1896, and then spread over the United States.
- 1897** | The last public hanging in West Virginia was in Jackson County in December of 1897.
- 1903** | On January 23, 1903, the Legislature of West Virginia adopted the State Flower, the Rhododendron. (Rhododendron Maximum or “Big Laurel”)
- 1908** | On May 10, 1908, the international holiday known as Mother’s Day originated at the instigation of Anna Jarvis, of Grafton, at the Andrews Methodist Church in Grafton, which is now the International Mother’s Day Shrine. The Andrews Methodist Church is now listed on the National Register of Historic Places.
- 1908** | Outdoor advertising had its origin in Wheeling about 1908 when the Block Brothers Tobacco Company painted bridges and barns with their wording: “Treat Yourself to the Best, Chew Mail Pouch.”
- 1919** | The West Virginia State Police was created.
- 1921** | West Virginia became the first state in the nation to have sales tax when the gross sales tax became effective on July 1, 1921. (The consumers sales tax was enacted in 1933 and became effective April 1, 1934).
- 1923** | West Virginia’s first memorial building to World War I veterans, located in Welch, was dedicated on May 30, 1923.
- 1925** | The only federal prison in the United States exclusively for women is at Alderson. The building of this institution was started December 31, 1925.
- 1926** | The first radio station in West Virginia, WWVA in Wheeling, went on the air on December 13, 1926. WSAZ is older, but until 1926, it was based in Pomeroy, Ohio.
- 1932** | What is said to be the third largest one-piece rug in the world, 72’ x 27’, once in the Governor’s Reception Room at the State Capitol, has been replaced. The present Chinese Oriental Rug was donated by a Charleston businessman.
- 1933** | On October 12, 1933, the first regular aviation service in West Virginia began in Charleston.
- 1933** | The largest shipment of matches ever sent (20 carloads or 810,000,000 matches) was shipped from Wheeling to Memphis, Tennessee, on August 26, 1933.

- 1933** | Sixty-five tons of bituminous coal was used in the construction of the Coal House in Williamson, WV. It is on the National Register of Historic Places. On September 23, 1938, in Mingo County, the Mingo Oak, largest and oldest white oak tree on record in the United States, was declared dead and felled with ceremony.
- 1948** | Charles Yeager of Hamlin made the first “faster-than-sound” flight, breaking the sound barrier on October 14, 1948.
- 1949** | On October 14, 1949, the first television station in West Virginia, WSAZ-TV went on the air in Huntington.
- 1954** | West Virginia’s Memorial Tunnel, on the West Virginia Turnpike, was the first in the nation to be monitored by television cameras. It opened November 8, 1954.
- 1955** | The state record muskie, 43 pounds, was caught on March 15, 1955.
- 1956** | The first State-owned vacation lodge, Cacapon Lodge, located in Cacapon State Park, near Berkeley Springs, was dedicated June 30, 1956.
- 1961** | Coal House, the only residence in the world built completely of coal, is located in White Sulphur Springs. The house was occupied by Mr. and Mrs. David T. Myles on June 1, 1961.
- 1963** | “The West Virginia Hills,” “This is My West Virginia,” and “West Virginia, My Home Sweet Home” were each designated as the official state songs of West Virginia, each ranking equally with the others in official status, by House Concurrent Resolution 19, adopted by the Legislature on February 18, 1963.
- 1963** | Old Gold and Blue were designated as the official state colors by Senate Concurrent Resolution No. 20, adopted by the Legislature on March 8, 1963.
- 1972** | A variety of the yellow apple, the Golden Delicious, originated in Clay County. In honor of this apple, the Clay County Golden Delicious Festival was chartered in 1972, by the Clay Lions Club. The festival, an annual event, has been sponsored by the Veterans of Foreign Wars, Clay Post No. 4419 and its auxiliary since 1975. The original Grimes Golden Apple Tree was discovered in 1775 near Wellsburg.
- 1977** | New River Gorge Bridge, world’s largest single-arch steel span to date, completed.
- 1988** | Completion of I-64 from Virginia to Beckley, WV opens southern West Virginia to trade and tourism.
- 1995** | Dedication of the Veterans’ Memorial at the State Capital on November 11.
- 1996** | Appalachian Corridor G from Charleston to Williamson completed.
- 1996** | Dedication of the Robert C. Byrd statue at the State Capital on December 11.
- 1997** | Inauguration of Governor Cecil Harland Underwood on January 13, 1997.
- 1997** | Monongahela silt loam, declared official state soil. The Legislature passed the concurrent resolution during the regular legislative session, making West Virginia the twelfth state to have an official state soil.

- 1999** | The massive radio telescope being built in Green Bank sets the stage for a new century of exploring the universe. The smaller dish collapsed in 1988.
- 1999** | Toyota USA Engine Plant completed in Buffalo, West Virginia. Expansion plans were announced by Toyota prior to proposed opening.
- 1999** | “Celebration 2000” is being organized to welcome the turn of the century. Y2K concerns are being evaluated to assure an orderly transition from the twentieth century to the twenty-first century.
- 2000** | Shelley Moore Capito, first woman elected to the United States Congress from the state of West Virginia, November 7, 2000.
- 2001** | On Tuesday morning, September 11, 2001, two hijacked jetliners hit the World Trade center in New York City and one hit the Pentagon just outside Washington, D.C. A fourth hijacked plane crashed into a field in Pennsylvania.
- 2002** | Senator Robert C. Byrd was named the 2002 West Virginian of the Year by the Sunday Gazette-Mail.
- 2003** | On April 1, Private Jessica Lynch of Palestine (Wirt County) was rescued by U.S. forces. Lynch had been captured in an ambush on March 23, and was being held by Iraqi forces as a prisoner of war. Her rescue was one of the more dramatic and controversial episodes of the war in Iraq.
- 2004** | Three starting quarterbacks in the National Football League played their college years at West Virginia schools. Chad Pennington, who started for the New York Jets, and Byron Leftwich, Jacksonville Jaguars’ starting quarterback, played at Marshall University, while Marc Bulger of the St. Louis Rams spent his college career at West Virginia University.
- 2005** | The West Virginia University Basketball team advanced to the NCAA Elite Eight, but were defeated by Louisville in the semi-finals.
- 2006** | Twelve miners died and a 13th was critically injured after an explosion ripped through the International Coal Group mine south of Buckhannon, Upshur County, early on the morning of January 2. One miner was killed by the blast itself. Eleven others were dead by the time rescuers reached them more than 40 hours later. The lone survivor was Randall McCloy, Jr.
- 2010** | Twenty-Nine miners died and two were injured on April 5, 2010, after an explosion in the Upper Big Branch mine, Raleigh County, making it the nation’s worst coal mining disaster in 40 years.
- 2010** | The West Virginia University basketball team advanced to the NCAA Final Four but was defeated by Duke.
- 2010** | Robert Carlyle Byrd, Jr. (November 20, 1917 - June 28, 2010) a United States Senator from West Virginia died. A member of the Democratic Party, Byrd served as a senator from 1959 to 2010 and was the longest-serving senator and the longest serving member in the history of the United States Congress.
- 2010** | Carte Goodwin, 36, was appointed by Governor Joe Manchin, III to serve until a special election in November to decide who would hold the seat. Joe Manchin III was elected on November 2, 2010, to fill Senator Byrd’s remaining term.

Material confirmed by the West Virginia Library Commission

WEST VIRGINIA FACTS

The biggest threat to West Virginia's forests is fire. In a ten-year period from 1986 to 1995, forest fires burned a yearly average of 97,470 acres. The damage during that ten-year period, including damage to homes, structures, and other land, has been computed to be \$21,630,577.

The third-largest diamond ever found in the United States, the "Punch" Jones Diamond, was found near Peterstown in Monroe County within one-half mile of the Virginia state line. It has been suggested that the diamond actually occurred in rocks in Virginia and that erosion carried it to the West Virginia side of the state line. There are no other likely sites for diamonds in this state. No other precious gems are known to have been found in West Virginia. Among the few gemstones found in West Virginia are some opal, some types of quartz, and two coal or coal-like minerals, which though softer than most gemstones, are cut, polished, and carved into jewelry.

A variety of the yellow apple, the Golden Delicious, originated in Clay County. The original Grimes Golden Apple Tree was discovered in 1775, near Wellsburg.

The first steamboat was launched by James Rumsey in the Potomac River at New Mecklenburg (Shepherdstown) on December 3, 1787.

On February 14, 1824, at Harpers Ferry, John S. Gallaher published the "Ladies Garland," one of the first papers in the nation devoted mainly to the interests of women.

One of the first suspension bridges in the world was completed in Wheeling in November 1849.

Bailey Brown, the first Union soldier killed in the Civil War, died on May 22, 1861, at Fetterman, Taylor County.

A naval battle was fought in West Virginia waters during the Civil War. United States Navy armored steamers were actively engaged in the Battle of Buffington Island near Ravenswood on July 19, 1863.

Mother's Day was first observed at Andrews Church in Grafton on May 10, 1908.

The first rural-free mail delivery began in Charles Town, October 6, 1896, then spread across the United States.

Outdoor advertising had its origin in Wheeling about 1908 when the Block Brothers Tobacco Company painted bridges and barns with the wording: "Treat Yourself to the Best, Chew Mail Pouch."

West Virginia was the first state to have a sales tax. It became effective July 1, 1921.

Mrs. Minnie Buckingham Harper, a member of the House of Delegates by appointment in 1928, was the first African American woman to become a member of a legislative body in the United States.

West Virginia's Memorial Tunnel was the first in the nation to be monitored by television. It opened November 8, 1954.

West Virginia was the first state to use new technology to “measure” and store electronically the face and fingertip images of licensed drivers. Because this recorded information is unique to each individual, these images can prevent stolen identity should a driver’s license be lost or stolen.

The longest single-span steel arch bridge in the United States and the third highest bridge in the country (1,700 feet) is the New River Gorge Bridge in Fayette County.

Organ Cave, near Ronceverte, is the third largest cave in the United States and the largest in the state.

West Virginia has a mean altitude of 1,500 feet, giving it the highest average altitude east of the Mississippi.

West Virginia’s Snowshoe Mountain has been named the top ski resort in the Mid-Atlantic and Southeast, boasting 57 downhill runs and usually the best ski conditions south of Vermont.

There are more than one-million acres of protected public forests and five federal wilderness areas in the Potomac Highlands region alone.

The New River is actually the second-oldest river in the world, trailing only the Nile. The 876-foot-high New River Gorge Bridge near Fayetteville is the second-largest steel-arch bridge in the world and the second-highest bridge in the United States.

The tiny town of Bramwell, which boasted as many as 19 millionaires during coal’s heyday, was once considered the “Wealthiest Town in America”.

Water from the Pence Springs Hotel won the Silver Medal at the 1904 World’s Fair in St. Louis.

The release of the mighty Summersville Dam is responsible for creating the world-class whitewater rapids that make up “Gauley Season” each fall.

Public Radio’s international live-music show, Mountain Stage, is recorded at the Culture Center in Charleston and often travels to present shows at other venues.

Camden Park near Huntington is home of The Big Dipper, which is in the Coaster Hall of Fame, and The Lil’ Dipper, the only children’s wooden coaster still running in the country.

Cabin Creek Quilts in Malden, south of Charleston, grew from a half-dozen women to the largest quilting co-op in the United States.

Wine Cellar Park in Dunbar was once a stop on the Underground Railroad.

The southern community of Matewan is the home of the infamous Hatfield-McCoy feud and, 40 years later, the Matewan Massacre, one of the bloodiest conflicts in West Virginia’s coal mine wars.

The country’s leading manufacturer of hand-made glass was Fenton Art Glass in Williamstown. Founded in 1905, the company ceased traditional glassmaking in 2011.

The town of Chester in the northern panhandle proudly boasts “The World’s Largest Teapot.”

Wheeling witnessed the last battle of the American Revolution, the coming of the National Road, the first bridge across the Ohio River, and an industrial boom that built vast fortunes and Victorian mansions.

Morgantown, home to the West Virginia University Mountaineers, has been recognized as the Best Small City East of the Mississippi.

Clarksburg's Italian Heritage Festival has been named one of the 100 Best Ethnic Events in America.

During the Civil War, the town of Martinsburg passed between Union and Confederate hands as many as 60 times.

West Virginia's eastern panhandle is less than an hour's drive from our nation's capital in Washington, D.C.

There is an exhibition mine near Beckley, operated for tourists, where visitors are taken through an authentic coal mine.

West Virginia has an average altitude of 1,500 feet, giving it the highest average altitude of any state east of the Mississippi River.

The lowest point in West Virginia is Harpers Ferry in Jefferson County, at 247 feet above sea level. The highest point in West Virginia is Spruce Knob in Pendleton County, at 4,861 feet above sea level.

The Paw Paw, nicknamed the "West Virginia Banana" is North America's largest edible native fruit and is found throughout all 55 West Virginia counties (as well as most of the eastern United States). It gave its name to the town of Paw Paw, West Virginia in Morgan County.

The 1500 block of Virginia Street, East, in Charleston, is considered the longest residential block in the world.

The Monarch Butterfly is the State Butterfly. The State Fish is the Brook Trout and the Fossil Coral is the State gem. In the 2002 legislative session the Honey Bee was named the State Insect. In the 2009 legislative session bituminous coal became the official State Rock. In the 2021 legislative session the Pepperoni Roll became the official state food.

The New River Gorge in Fayette County became the country's 63rd National Park on December 27, 2020.

On August 11, 2023, Governor Jim Justice signed newly passed legislation naming 177 acres on the northern shore of Summersville Lake as West Virginia's 36th state park.

FAMOUS WEST VIRGINIANS

The following individuals are a small collection of famous West Virginians from different walks of life and their invaluable contributions adding to the rich history of West Virginia. This is by no means a definitive list as West Virginia has been home to many that have developed their careers in journalism, education, sports, the arts, and the frontiersmen who helped to shape West Virginia. The list would take many more pages to acknowledge the numerous accomplishments these West Virginians have had on our State that we are so proud to call Mountaineers.

JARED MAURICE ARTER (1850 - 1930)

Born into slavery, in Jefferson County, West Virginia. Under the Emancipation Proclamation of 1863, Arter's family was freed from slavery. He received a PhD at Pennsylvania State College, and a BD at Hillsdale College and Chicago Theological Seminary. In 1921 Arter was serving as pastor of Curtis Free Will Baptist Church in Harpers Ferry. He was a Republican, missionary baptist, and mason. Arter is the author of the slave narrative, *Echoes From a Pioneer Life*.

RANDY BARNES (1966 -)

Perhaps the world's greatest shot-putter. He holds both the outdoor and indoor world records and was a gold medalist in the 1996 Atlanta Olympics. He grew up in St. Albans, Kanawha County.

PEARL BUCK (1892 - 1973)

American novelist, born in Hillsboro, Pocahontas County. She was awarded the Nobel Prize in literature and the Pulitzer Prize for fiction. Many of her more than 85 books sympathetically portray China and its people.

ROBERT CARLYLE BYRD (1917 - 2010)

Elected in 2006 to a ninth consecutive term in the U.S. Senate. He was the Majority Leader of the Senate from 1977 to 1981 and from 1987 to 1989. Byrd was from Sophia, Raleigh County.

JOHN ROBERT CLIFFORD (1848 - 1933)

Born in 1848 in Williamsport, WV. In 1887, he became the first African American attorney admitted to the West Virginia State Bar. In 1898, Clifford won a landmark civil rights and education case before the West Virginia Supreme Court of Appeals. In *Williams v. Board of Education*, Clifford argued against the Tucker County Board of Education's decision to shorten the school year for African-American school children from nine months to five months, keeping a full term for white students. He practiced law for forty-five years and was active in both state and national politics as a Republican. Clifford was among the founders of the Niagara Movement. In 1906, the Niagara Movement's first American meeting occurred in Harpers Ferry, West Virginia. The Niagara Movement led to the formation of the NAACP a few years later and is considered to be the cornerstone of the modern Civil Rights Movement.

BOB DENVER (1935 - 2005)

Played Gilligan on the TV series "Gilligan's Island" and Maynard G. Krebs on the TV series "The Many Loves of Dobie Gillis," and lived near Princeton, Mercer County. His wife, Dreama, is from WV.

JENNIFER GARNER (1972 -)

Starred in the ABC series "Alias." She has appeared in films such as "Pearl Harbor," "Elektra," and "Miracles from Heaven" and has been featured in several television films and had regular roles in television series. She was born in Houston but grew up in the Charleston area and graduated from George Washington High School.

HENRY LOUIS “SKIP” GATES, JR. (1950 -)

American literary critic, teacher, historian, filmmaker, and public intellectual who currently serves as the Alphonse Fletcher University Professor and Director of the Hutchins Center for African and African American Research at Harvard University.

HOMER H. HICKAM, JR. (1943 -)

Author of “Rocket Boys: A Memoir,” the story of his life in the little town of Coalwood, McDowell County, that inspired the number one bestseller and award-winning movie “October Sky.”

KATHERINE COLEMAN GOBLE JOHNSON (1918 - 2020)

African-American mathematician who made contributions to the United States’ aeronautics and space programs with the early application of digital electronic computers at NASA. Known for accuracy in computerized celestial navigation, she conducted technical work at NASA that spanned decades. During this time, she calculated the trajectories, launch windows, and emergency back-up return paths for many flights from Project Mercury, including the early NASA missions of John Glenn and Alan Shepard, and the 1969 Apollo 11 flight to the Moon, through the Space Shuttle program. In 2015, Johnson received the Presidential Medal of Freedom.

THOMAS JONATHAN “STONEWALL” JACKSON (1824 - 1863)

General in the Confederacy during the Civil War and is considered among the most skillful tacticians in military history. He was born in Clarksburg (then Virginia).

ANNA JARVIS (1864 - 1948)

Considered the founder of Mother’s Day. Following the death of her own mother in 1905, she began campaigning to have one day a year set aside to honor mothers. In 1914, President Woodrow Wilson signed a proclamation declaring Mother’s Day a holiday. She was born near Grafton, Taylor County.

JESSE DONALD “DON” KNOTTS (1924 - 2006)

Television and movie actor, was born in Morgantown (Monongalia County) to a farm family he described as “dirt poor.” He attended West Virginia University where he majored in speech, hoping to become a teacher. Knotts played the role of Barney Fife on the “Andy Griffith Show.”

CAPTAIN JON A. MCBRIDE (1943 - 2024)

Became an astronaut in August 1979, and piloted the Challenger when it was launched on October 5, 1984. He was a Republican candidate for Governor of West Virginia in 1996. McBride was born in Charleston, Kanawha County.

KATHY MATTEA (1959 -)

Country music star and two time grammy award winner, was born in South Charleston and grew up in Cross Lanes, Kanawha County.

JOHN FORBES NASH JR. (1928 - 2015)

Described as a mathematical genius who essentially lost 30 years of his life to paranoid schizophrenia and who reemerged into public glory (once the disease was in remission) to receive the 1994 Nobel Prize in Economics for a brilliant doctoral dissertation begun in 1950, “A Beautiful Mind,” a biography of Nash by Sylvia Nasar, inspired a movie of the same name. Nash was born and raised in Bluefield, Mercer County.

BRAD PAISLEY (1972 -)

Grammy award-winning country music star and 2008 Country Music Association Vocalist of the Year. He was born in Glen Dale, Marshall County, where his father retired as assistant fire chief.

MARY LOU RETTON (1968 -)

Gymnast who won four medals in the 1984 Summer Olympics, including the gold in the all-around gymnastics competition. She is from Fairmont, Marion County.

LEON HOWARD SULLIVAN (1922 - 2001)

Baptist minister, civil rights leader and social activist focusing on the creation of job training opportunities for African Americans, a longtime General Motors Board Member, and an anti-Apartheid activist. Born in Charleston, West Virginia. He was raised on a dirt alley called Washington Court in one of Charleston's poorest sections. Sullivan has often re-told the event which set a course for the remainder of his life. At the age of twelve, he tried to purchase a Coca-Cola in a drugstore on Capitol Street. The proprietor refused to sell him the drink, saying: "Stand on your feet, boy. You can't sit here." This incident inspired Sullivan's lifetime pursuit of fighting racial prejudice.

JEROME ALAN "JERRY" WEST (1938 - 2024)

Professional basketball star for the Los Angeles Lakers, was chosen as one of the greatest National Basketball Association basketball players in 1996. He was born in Cabin Creek, Kanawha County.

CHARLES ELWOOD "CHUCK" YEAGER (1923 - 2020)

Became the first person to fly faster than the speed of sound in October 1947 and the first person to fly more than twice the speed of sound in December 1953. He was born in Myra, Lincoln County.

PRESIDENTS OF THE UNITED STATES



The seal of the president of the United States includes an eagle holding arrows and an olive branch. The branch symbolizes the desire for peace, and the arrow represents the ability to wage war. The 50 stars stand for the 50 U.S. states.

The President of the United States is often considered the most powerful elected official in the world. The president leads a nation of great wealth and military strength. Presidents have often provided decisive leadership in times of crisis, and they have shaped many important events in history.

The Constitution of the United States gives the president enormous power. However, it also limits that power. The authors of the Constitution wanted a strong leader as president, but they did not want an all-powerful king. As a result, they divided the powers of the United States government among three branches—executive, legislative, and judicial. The president, who is often called the chief executive, heads the executive branch. Congress represents the legislative branch. The Supreme Court of the United States and other federal courts make up the judicial branch. Congress and the Supreme Court may prevent or end any presidential



PRESIDENTS OF THE UNITED STATES

action that exceeded the limits of the president's powers and trespasses on their authority.

The president has many roles and performs many duties. As chief executive, the president makes sure that federal laws are enforced. As commander in chief of the nation's armed forces, the president is responsible for national defense. As foreign policy director, the president determines U.S. relations with other nations. As legislative leader, the president recommends laws and works to win their passage. As head of a political party, the president helps mold its positions on national and foreign issues. As popular leader, the president tries to inspire the people of the United States to work together to meet the nation's goals. Finally, as chief of state, the president performs a variety of ceremonial duties.

Qualifications: A candidate for the presidency must be a "natural-born" United States citizen

of at least 35 years old and must have lived in the United States for at least 14 years.

How nominated: By a national political party convention.

How elected: By a majority vote of the Electoral College.

Term: Four years. May not be elected more than twice.

Succession: If a president dies, resigns, is disabled, or is removed from office, the vice president assumes the office.

Income: Yearly salary of \$400,000. Annual allowance of \$50,000 and additional allowances for travel, staff and White House Maintenance.

From The World Book Encyclopedia, (c) 2008, World Book, Inc. www.worldbook.com

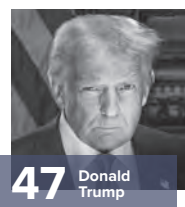
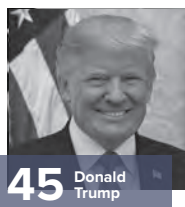
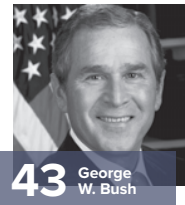
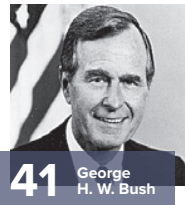
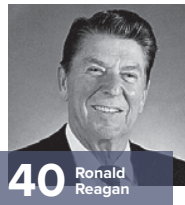
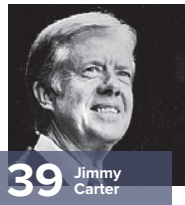
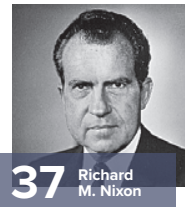
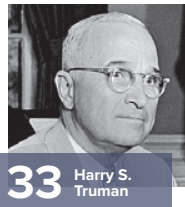
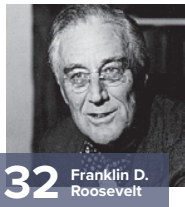
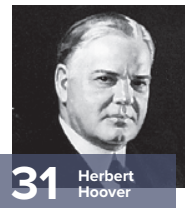
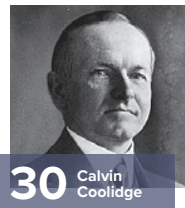
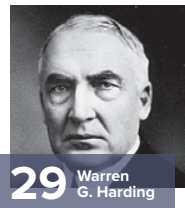
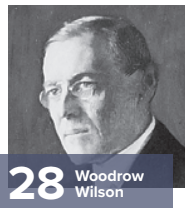
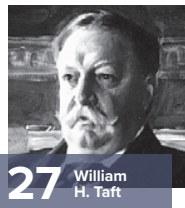

FEDERAL FLAG CODE

The United States flag is considered to be a living symbol representing our country. In addition, the flag represents the many freedoms, rights and responsibilities entrusted to the citizens of this country. Therefore, the proper display and use of the American flag is the responsibility of every American. The flag code is simply a guideline for proper display of, and honor to, our flag. There are no penalties for violation of the provisions of the code. However, state and federal law may apply to specific acts against the flag.

YOU DO

- Display the flag from sunrise to sunset. If displayed after sunset, the flag should be illuminated.
- Raise the flag briskly and lower the flag slowly.
- Fly an all-weather flag, if the weather is bad.
- Fly the flag on all designated days, like the Fourth of July. These are suggested days of historic meaning. You can fly it every day of the year.
- Fly the flag every day at all public buildings.
- Fly the flag where people vote on election day.
- Fly the flag at every school when school is in session.
- Destroy a soiled, faded or badly torn flag in a dignified way, preferably by burning.

DO NOT

- You do not fly the flag upside down unless there is a dire emergency.
- You do not let the flag touch the ground.
- You do not carry the flag flat, or carry things in it. Always fly it aloft and free.
- You do not use the flag as clothing.
- You do not store the flag where it can be soiled or damaged.
- You do not draw on, or otherwise mark the flag.
- You do not use the flag as a uniform. Certain groups may have an American flag patch on their uniform, placed in accordance with the flag code.
- You do not use the flag as a drapery, drawn back or in folds. It will always be allowed to fall free.
- You do not use the flag as a ceiling or table cloth.
- You do not use the flag for advertising purposes in any manner whatsoever.

QUESTIONS AND ANSWERS

Q. Is it proper to place a Bible, flowers or other objects upon the American flag?

A. No, nothing should ever rest on our flag.

Q. Is it correct to fly the American flag at half-staff on Veterans Day?

A. No, because this day, originally known as Armistice Day, is a day of celebration not for mourning.

Q. If there are two flags on two poles at the entrance of the building, on which side should the American flag be flown?

A. On your left as you walk into the building.

Q. Is it permissible to wear a button or a pin properly depicting the American flag?

A. Yes, these may be worn as a demonstration of your patriotism.

Q. What is the proper method of saluting our flag?

A. Men place their right hand over their heart, holding a hat or cap at the left shoulder if wearing one. Women will place their right hand over their heart. Persons in uniform render the military salute.

Q. Which way do I face to give the salute?

A. To the flag if one is being flown, otherwise to the music. During the National Anthem, hold your salute until the music is finished.

DESCRIPTION OF THE FLAG

The flag of the United States has 13 stripes, seven red and six white, with red on the top and bottom. The stripes represent the 13 original colonies that became the first 13 states.

The blue field (the union) with 50 stars is located next to the staff in the upper left corner of the flag. It extends from the top of the flag to the lower edge of the fourth red stripe. The stars are arranged in alternating rows of six and five, representing the 50 states of the United States.

SYMBOLISM OF THE FLAG

Flags and decorations through the centuries have used colors and symbols to embody the feelings of the people or events that they recognize. Our flag can be said to represent:

RED	Valor and zeal	BLUE	Reverence and loyalty (color of the heavens)
WHITE	Hope and cleanliness of life	STARS	Constellation of the states (symbol of the heavens)

RESPECT FOR THE FLAG

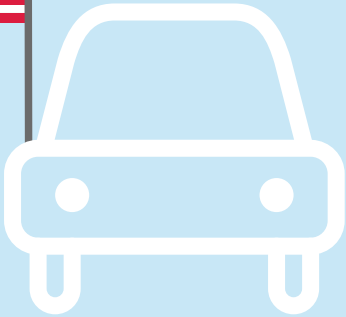
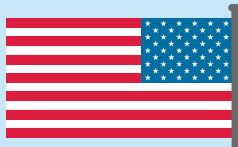

On a car, fasten the flag staff to the chassis or front fender on the passenger side.

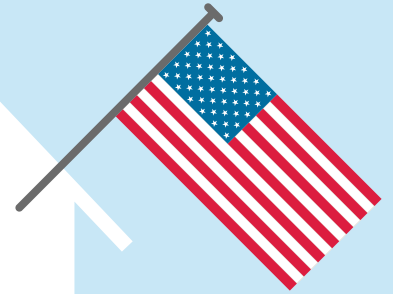

From a building, the union will be at the peak, if from a rope, the same, with the union first out of the building.

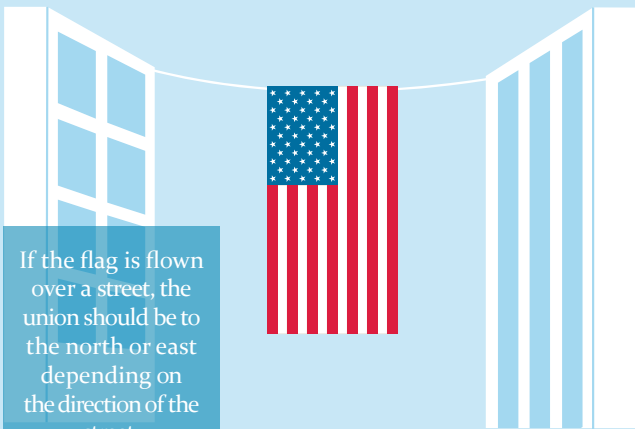

If the flag is flown over a street, the union should be to the north or east depending on the direction of the street.

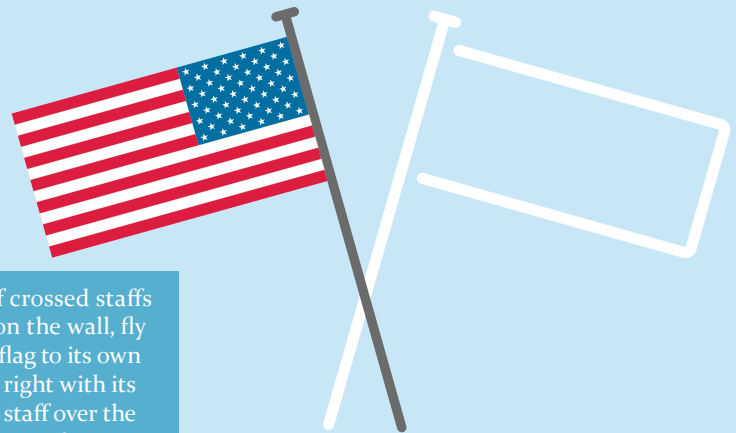

If crossed staffs on the wall, fly flag to its own right with its staff over the other.

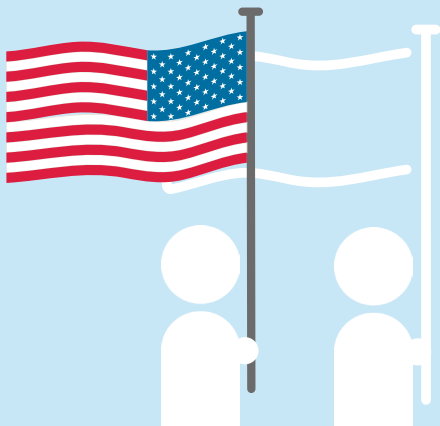

RIGHT

When marching carry the flag on the right side or centered and in front of other flags. The flag is normally not dipped.

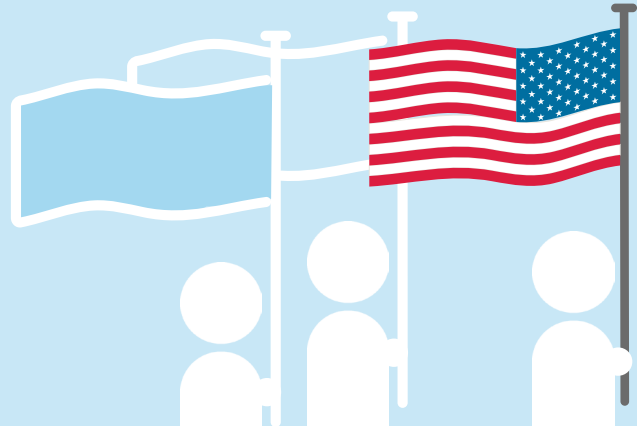

CENTER

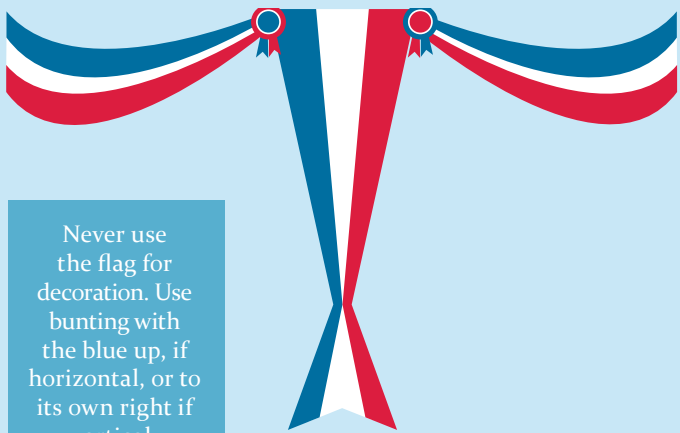

Never use the flag for decoration. Use bunting with the blue up, if horizontal, or to its own right if vertical.

Fly the flag above any other flag, or on the flag's own right side if all the same height. If the flags are in a semicircle, fly the American flag above the other, in the center.

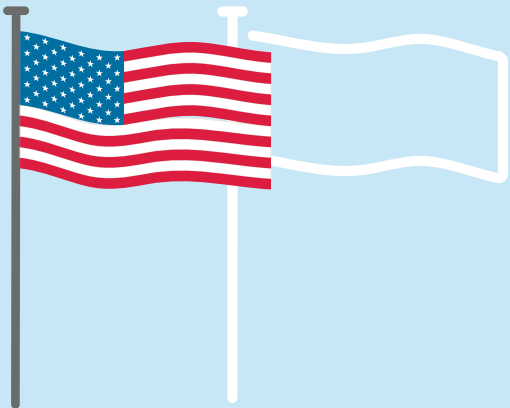

On special days, the flag may be flown at half-staff. On Memorial Day it is flown at half-staff until noon, then it is raised to the top of the flag pole.

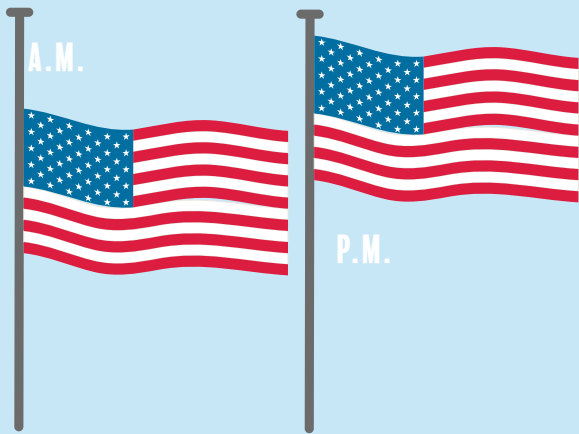

Keep your flag dry and folded properly into a triangle with the union visible.



Flags displayed at night should be properly illuminated.



The flag shouldn't be flown in inclement weather unless it's an all-weather flag.

When displayed with a speaker's platform, it must be above and behind the speaker. Use bunting, not a flag, to decorate a platform.

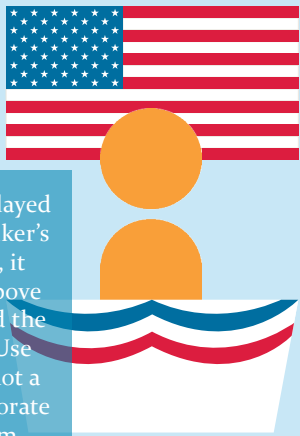

On a single flagstaff, fly the American flag at the top, so it will be hoisted first and lowered last.

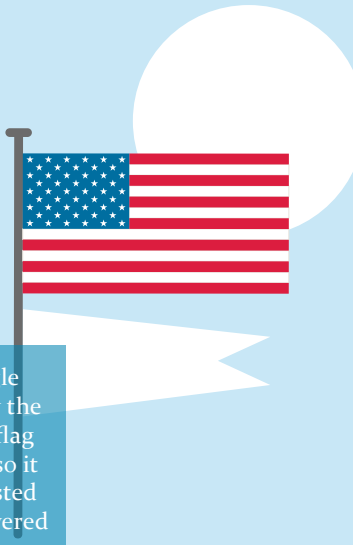

The flag should not touch anything below it or rest on the ground.

HISTORY OF THE AMERICAN FLAG

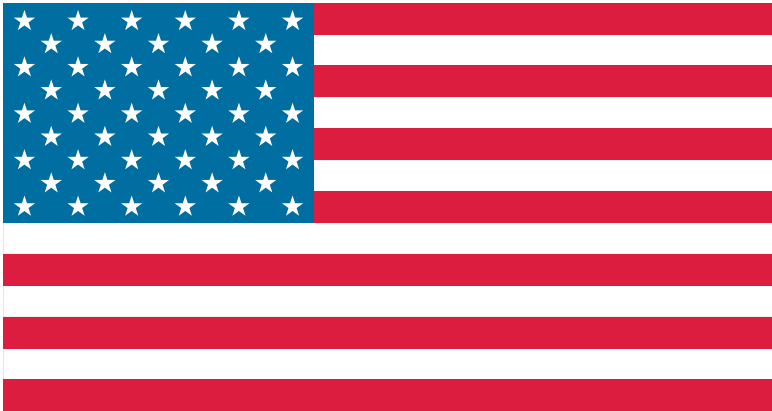

According to popular legend, the first American flag was made by Betsy Ross, a Philadelphia seamstress who was acquainted with George Washington, leader of the Continental Army, and other influential Philadelphians. In May 1776, so the story goes, General Washington and two representatives from the Continental Congress visited Ross at her upholstery shop and showed

her a rough design of the flag. Although Washington initially favored using a star with six points, Ross advocated for a five-pointed star, which could be cut with just one quick snip of the scissors, and the gentlemen were won over.

Unfortunately, historians have never been able to verify this charming version of events, although it is known that Ross made flags for the navy of Pennsylvania. The story of Washington's visit to the flag maker became popular about the time of the country's first centennial, after William Canby, a grandson of Ross, told about her role in shaping U.S. history in a speech given at the Philadelphia Historical Society in March 1870.

What is known is that the first unofficial, national flag, called the Grand Union Flag or the Continental Colours, was raised at the request of General Washington near his headquarters outside Boston, Mass., on January 1, 1776. The flag had 13 alternating red and white horizontal stripes and the British Union Flag (a predecessor of the Union Jack) in the canton. Another early flag had a rattlesnake and the motto "Don't Tread on Me."

The first official national flag, also known as the Stars and Stripes, was approved by the Continental Congress on June 14, 1777. The blue canton contained 13 stars, representing the original 13 colonies, but the layout varied. Although nobody knows for sure who designed the flag, it may have been Continental Congress member Francis Hopkinson.

After Vermont and Kentucky were admitted to the Union in 1791 and 1792, respectively, two more stars and two more stripes were added in 1795. This 15-star, 15-stripe flag was the "star-spangled banner" that inspired lawyer Francis Scott Key to write the poem that later became the U.S. national anthem.

In 1818, after five more states had gained admittance, Congress passed legislation fixing the number of stripes at 13 and requiring that the number of stars equal the number of states. The last new star, bringing the total to 50, was added on July 4, 1960, after Hawaii became a state.

POINTS OF INTEREST

HARPERS FERRY

In addition to its fabulous scenery, Harpers Ferry was the site of the first successful application of interchangeable manufacturing, the arrival of the first successful American railroad, John Brown's attack on slavery, the largest surrender of federal troops during the Civil War, and the education of former slaves in one of the earliest integrated schools in the United States.

NEW RIVER GORGE

Encompassing over 70,000 acres of land along the New River, this national park protects 53 miles of free-flowing water. The gorge, carved by the world's second-oldest river, has been dubbed the "Grand Canyon of the East." A new eco-friendly visitor center opened near Sandstone in 2003.

THE GREENBRIER RESORT

The Greenbrier is a AAA Five Diamond award-winning resort nestled on 6,500 acres in the scenic Allegheny Mountains in White Sulphur Springs. This world-renowned getaway offers more than 50 activities, including three 18-hole championship golf courses, a golf academy, a Land Rover driving school, a gallery of fine shops and a host of traditional amenities that have distinguished the resort for more than 200 years. In 2003, readers of "Conde Nast Traveler" magazine voted the Greenbrier one of the "Best of the Best" golf resorts in the world and the number two spa resort in North America.

BERKELEY SPRINGS

Located in the Town of Bath, Berkeley Springs for 250 years has been famous for their warm waters attracting Native Americans from Canada to the Carolinas. George Washington even slept here. Today, Berkeley Springs offers state-of-the-art spas, unique shops, outdoor adventures and local arts.

WEST VIRGINIA SCENIC RAILROADS

West Virginia features a variety of railroad attractions, including the world-famous Cass Scenic Railroad State Park and the Mountain State Mystery Train and New River Gorge excursions. There are also diesel favorites like the Potomac Eagle excursions, on which passengers enjoy a 90 percent chance of seeing a bald eagle. There's also the recently expanded Durbin & Greenbrier Valley Railroad. The state is steeped in railroad traditions and there are a number of historic facilities that mark this culture.

STONEWALL RESORT

Opened in 2002, Stonewall Resort is the latest development in state park facilities. The resort sits along the shore of the state's second-largest impoundment, Stonewall Jackson Lake, and features an Arnold Palmer-designed championship golf course, lodge, deluxe cottages, houseboat rentals and a spa.

TAMARACK

Tamarack is the nation's first and only statewide collection of handmade craft, art, and cuisine showcasing "The Best of West Virginia" from hand-carved furniture to glass, from pottery to Appalachian quilts and more. Tamarack offers regional specialty foods and products, as well as performances, craft demonstrations, shopping, theater, an art gallery, and a food court managed by The Greenbrier.

OGLEBAY RESORT AND THE WINTER FESTIVAL OF LIGHTS

Oglebay is a 2,000-acre resort with abundant recreational activities, deluxe accommodations, a zoo, gardens, and shops nestled in the hills surrounding Wheeling. The resort features three golf courses and is home to America's largest light show, the Winter Festival of Lights. More than one million visitors and 3,000 tour buses visit the park and city each year to experience the show.

WEST VIRGINIA STATE PARK SYSTEM

The 36 state parks, nine state forests and three rail trails, and wildlife management areas comprise more than 180,000 acres set aside to protect regions of natural wonder, showcase scenic beauty, and preserve sites of historical significance. For years, the park system has been considered among the finest in the nation.

NATIONAL RADIO ASTRONOMY OBSERVATORY AT GREEN BANK

Home of the Green Bank Telescope, the world's largest moveable radio telescope. Here researchers study the universe through natural radio emissions. In 2003, a multi-million education center opened, providing visitors and school children additional opportunities to learn about this exciting field of science.

Information on any of the points of interest is available by calling the West Virginia Division of Tourism toll free at 1-800-CALL WVA or connecting to their website at www.callwva.com.

